

## Notes

Welcome to choose drum washing machine. This instruction manual includes the important information with regard to installation, operation and maintenance on this machine. Please read this manual carefully to ensure the proper operation of this washing machine and extend its working life. Our warranties shall not apply to any trouble and losses arising from the user's failure to observe the cautions mentioned in the installation and operation instructions, and we also assume no liability concerned. Please keep all documents in a safe place for future reference. If you have any doubt, please contact the nearest authorized service center or dealer.

### ■ Environmental Protection

- If you plan to dispose this machine, please comply with the local waste disposal regulations. Cut off the power cord so that it will not be put into reuse. Remove the door so that kids and animals will not be trapped in the machine.
- Do not use excessive detergents.
- Decontaminant and bleach can be used to pre-treat the stains on the clothes only when very necessary.

### ■ Contents

Safety Precautions.....	3
Overview of Washing Machine.....	5
Install Washing Machine.....	6
Operate Washing Machine.....	9
Checklist and Preparation before Washing Clothes.....	10
View of Control Panel.....	13
Select the procedure.....	14
Table of Washing Procedures.....	16
Maintenance.....	17
Troubleshooting.....	20
Appendix.....	22
Technical Specifications.....	23

## Safety Precautions

### ■ Before operating this machine

- Packing materials may be dangerous to the kids. Please keep all packing materials (plastic bags, foams etc) far away from the kids.
- Washing machine shall not be installed in bath room or very wet rooms as well as in the rooms with explosive or caustic gases.
- Make sure that the water and electrical devices must be connected by a qualified technician in accordance with the manufacturer's instructions (refer to page 7 "Installing Washing Machine) and local safety regulations.
- Before operating this machine, all packages and transport bolts must be removed. Otherwise, the washing machine may be seriously damaged while washing the clothes (refer to page 6 "Remove Transport Bolts".)
- Before washing the clothes at first time, the washing machine shall be operated in one round of the whole procedures without the clothes inside (refer to page 14 "Washing Clothes at First Time").
- This washing machine is for indoor use only.

### ■ Safety Cautions

- Pull out its plug from the power socket before cleaning or maintenance.
- Make sure that all pockets are emptied.
- Sharp and rigid items such as coin, brooch, nail, screw or stone etc. may cause serious damages to this machine.
- Pull out its plug and cut off water supply after the operation.
- Please check whether the water inside the drum has been drained before opening its door. Please do not open the door if there is any water visible,
- Pets and kids may climb into the machine. Check the machine before every operation.
- Glass door may be very hot during the operation. Keep kids and pets far away from the machine during the operation.
- This machine is not intended for use by persons (including kids) with reduced physical, sensory or mental capabilities, or lack of experience and knowledge, unless they have been given supervision or instruction concerning use of the machine by a person responsible for their safety.
- Kids should be supervised to ensure that they do not play with themachine.
- Do not try to repair the machine by yourself. The machine may be damaged or more troublesome repair work may be caused and even dangerous operation may take place if it is repaired by any inexperienced or unqualified staff.
- If the plug (power cord) is damaged, it shall be replaced by the manufacturer or a service agent to avoid any danger.
- Take care that power voltage and frequency shall be identical to those of washing machine.
- Do not use any socket with rated current less than that of washing machine. Never pull out power plug with wet hand.

## **Safety Precautions**

- To ensure your safety, power cord plug must be inserted into an earthed three-pole socket. Check carefully and make sure that your socket is properly and reliably earthed.
- This machine shall be repaired only by an authorized service center and only authentic accessories can be used.
- It is recommended to check regularly the supply cord for any sign of possible deterioration, and the appliance should not be used if the cable is damaged.
- This appliance has been incorporated with a grounded plug. Please ensure the wall outlet in your house is well earthed.

### **■ Cautions When Washing Clothes**

- Cold city water shall be used and hot water may be also connected according to the local situations.
- Your washing machine is only for home use and is only designed for the textiles suitable for machine washing.
- Flammable and explosive or toxic solvents are forbidden. Gasoline and alcohol etc. Shall not be used as detergents. Please only select the detergents suitable for machine washing, especially for drum.
- It is forbidden to wash carpets.
- Kids are forbidden to play with the washing machine.
- Keep pets far away from washing machine.
- Be careful of burning when washing machine drains hot washing water.
- Never refill the water by hand during washing.
- After the program is completed, Please wait for two minutes to open the door .
- Please remember to disconnect water and power supply immediately after the clothes are washed.

### **■ Attention shall be paid to protecting the machine**

- Do not climb up and sit on top cover of the machine.
- Do not lean against machine door.
- Please do not close the door with excessive forces. If it is found difficult to close the door, please check if the excessive clothes are put in or distributed well.

### **■ Cautions during Handling Machine**

- Transport bolts shall be reinstalled to the machine by a specialized person.
- The accumulated water shall be drained out of the machine.
- Handle the machine carefully. Never hold each protruded part on the machine while lifting. Machine door can not be used as the handle during the conveyance.

# Overview of Washing Machine

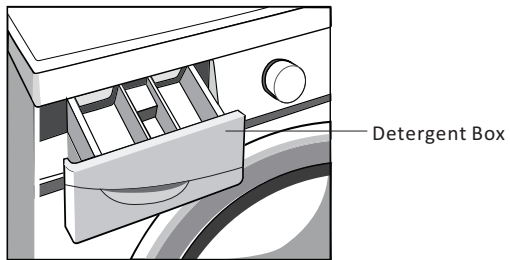
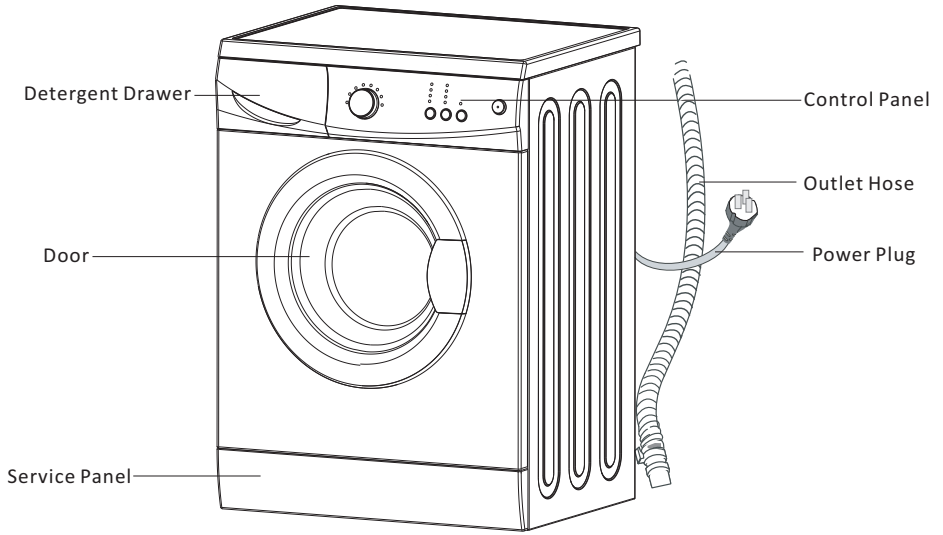

Transport Hole Plug



Inlet Pipe C



Inlet Pipe H (optional)

## Install Washing Machine

### ■ Unpacking the washing machine

Unpack your washing machine and check if there is any damage during the transportation. Also make sure that all the items (as shown in Page 5) in the attached bag are received. If there is any damage to the washing machine during the transportation, or any item is missing, please contact the local dealer immediately.

### ■ Dispose the packing materials

The packing materials of this machine may be dangerous to kids. Please dispose them properly and avoid easy touch by kids. Please dispose the related packing materials according to the relevant local regulations. Please do not throw the packing materials away together with the other daily living rubbishes.

### ■ Remove transport bolts

Before using this washing machine, transport bolts must be removed from the backside of this machine. Please take the following steps to remove the bolts:

1. Loosen all bolts with spanner and then remove them.
2. Stop the holes with transport hole plugs.
3. Keep the transport bolts properly for future use.

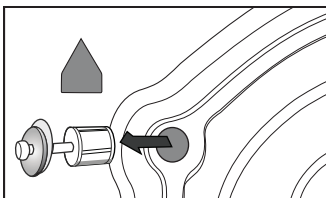

### ■ Select the location

Before installing the washing machine, the location characterized as follows shall be selected:

- Rigid, dry, and level surface (if not level, please make it level with reference to the following figure "Adjust Leg")
- Avoid direct sunlight
- Sufficient ventilation
- Room temperature is above 0 C
- Keep far away from the heat resources such as coal or gas.

Make sure that the washing machine will not stand on power cord.

Do not install the washing machine on the carpet floor.

### ■ Adjust Leg

1. When positioning the washing machine, please first check if the legs are closely attached to the cabinet. If not, please turn them to their original positions with hand or spanner and tighten the nuts with spanner.
2. After positioning the washing machine, press four corners on top cover of washing machine in sequence. If the washing machine is not stable when being pressed, this leg shall be adjusted.

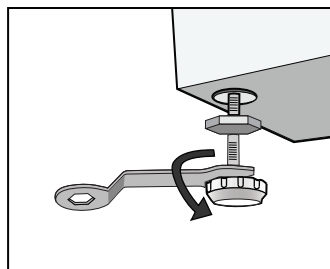

## Install Washing Machine

3. Ensure the positioning status of washing machine. Loosen the lock nut with spanner and turn the leg with hand until it closely contacts with the floor. Press the leg with one hand and fasten the nut closely to the cabinet with the other hand.
4. After being locked properly, press four corners again to make sure that they have been adjusted properly. If it is still unstable, it has to repeat Steps 2 and 3.
5. Put a solid cylinder (e.g. pop cans) oppositely on the top cover of the washing machine from in the left, right, front and back directions. If the cylinder keeps stable, the washing machine is positioned level. If it rolls, the washing machine is positioned unlevel. The rolling direction is the direction of lower ground surface. Then, the two legs in this direction shall be raised at the same time until the washing machine is level. Steps 1~3 are repeated to make the bottom legs closely against the ground and the nuts shall be locked tightly.

### ■ Connect inlet pipe

Connect the inlet pipe as indicated in the figure. For the model which has hot valve, please connect the hot valve to hot water tap. Energy will decrease automatically for some program.

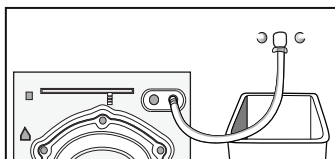

### ■ Install inlet pipe

1. Connect the elbow to tap and fasten it clockwise.
2. Connect the other end of inlet pipe to the inlet valve at the backside of washing machine and fasten the pipe tightly clockwise.

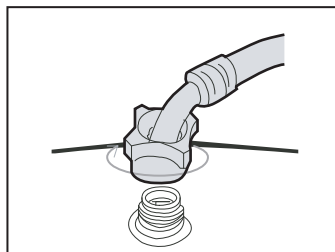

Notes: after connection, if there is any leakage with hose, then repeat the steps to connect inlet pipe. The most common type of tap shall be used to supply water. If tap is square or too big, then standard tap shall be changed.

### ■ Place outlet hose

- There are two ways to place the end of outlet hose:
1. Put it beside the water trough.

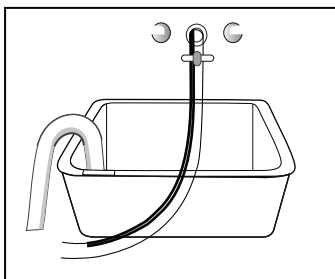

## Install Washing Machine

2.Connect it to the branch drain pipe of the trough.

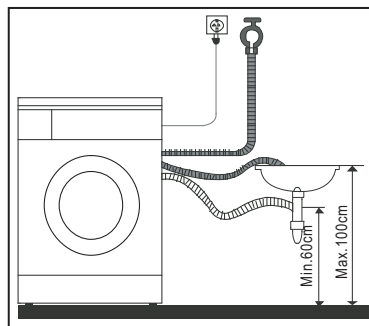
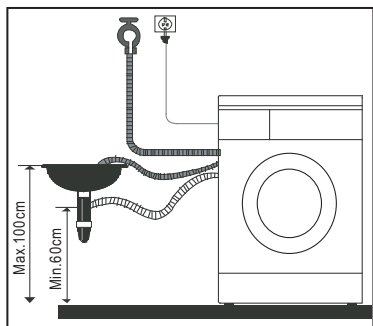

-It can drain the water up and down, outlet hose shall not be installed at a height beyond 100cm and its end shall not be immersed in water

Position outlet hose properly so that the floor will not be damaged by water leakage.

### ■ Electrical Connection

- As the maximum current through the unit is 10A when you are using its heating function, please make sure the power supply system (current, power voltage and wire) at your home can meet the normal loading requirements of the electrical appliances.
- Please connect the power to a socket which is correctly installed and properly earthed.
- Make sure the power voltage at your place is same to that in the machine's rating label.
- Power plug must match the socket and cabinet must be properly and effectively earthed.
- Do not use multi-purpose plug or socket as extension cord.
- Do not connect and pull out plug with wet hand.
- When connecting and pulling out the plug, hold the plug tightly and then pull it out. Do not pull power cord forcibly.
- If power cord is damaged or has any sign of being broken, special power cord must be selected or purchased from its manufacturer or service center for replacement.

## Install Washing Machine

### WARNING

1. **This machine must be earthed properly.** If there is any short circuit, earthing can reduce the danger of electrical shock.

This machine is equipped with power cord, which includes plug, earthing wire at earthing terminal.

2. Washing machine shall be operated in a circuit separate from other electrical appliances. Otherwise, power protector may be tripped or fuse may be burned out.

## Operate Washing Machine

### ■ Check list and Preparation before Washing Clothes

Please read this operation method carefully to avoid the troubles of washing machine and damages of clothes.

### ■ Check if the first-washed clothes will be decolorized.

After a white towel touched with liquid detergent is used to wash the invisible corners of the clothes, check if the white towel is stained with clothes' original color.

As for the scarves and those clothes that easily get decolorized among imported clothes, please wash them separately before washing.

As for the stains on sleeves, collars and pockets, use the liquid detergent and wash it with brush gently. Finally put them into the washing machine to achieve more ideal washing effects.

As for temperature-sensitive clothes, they shall be washed as required in the labels. Otherwise, it may cause color change or distortion.

### Keep in Mind:

Never put the clothes to be washed in washing machine for a long period of time.

Otherwise it may get moldy and cause spots. Therefore, please wash the clothes in time.

The clothes also may get color changed or distorted if they are not washed according to the stated washing temperature.

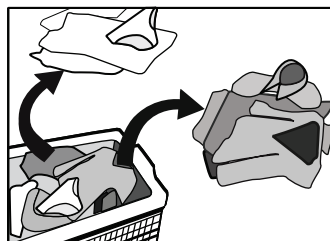

### ■ Clothes that can not be washed by washing machine

The clothes that may get distorted if being immersed in water:

Ties, waistcoats, western-style clothes, outer garments etc. may have obvious shrinkage if being immersed in water; the decolorized clothes such as blended spinning clothes of artificial fiber etc.



## Operate Washing Machine

Wrinkle-style clothes, embossed clothes, resin clothes etc. may get distorted when being immersed in water. Among cotton and wool materials, the clothes that get easily distorted are wrinkle-style silk, fur products and fur decorations;

Clothes with decoration, long dress and traditional clothes etc are the products to get decolorized easily.

Please do not wash the clothes without material labels and washing requirements.

Never wash the clothes stained with the chemicals such as gasoline, petroleum, benzene, paint thinner and alcohol.

### Please pay attention with regard to detergents

“Low bubble” detergent or washing powder or washing powder special for drum washing machine shall be selected according to fiber types (cotton, synthetic fiber, soft products and wool products), colors, washing temperatures, dirty degrees and types. Otherwise, excessive bubbles may be generated and overflowed out of the drawer so that accidents may take place.

Bleacher belongs to alkali type and can damage clothes, so it is suggested to use as little as possible.

Powder detergents can easily leave the residues in the clothes so as to generate the bad smell, so they shall be sufficiently rinsed.

Detergent can not easily get dissolved completely if there is too much detergent or water temperature is rather low. It can remain in clothes, pipes and washing machines to pollute the clothes.

Washing shall follow the weight of clothes, dirty degrees, local water hardness as well as the recommendations from the detergent manufacturers. Please consult the water company if you are not clear of water hardness.

#### Notes:

Keep detergents and additives in safe and dry places out of touch by kids.

### ■ Checklist and Preparation before Washing Clothes

#### Please take out the items out of the pockets.

Please check the pockets of the clothes to be washed, empty the rigid items such as decorations and coins, otherwise washing machine may be damaged or have abnormal troubles.

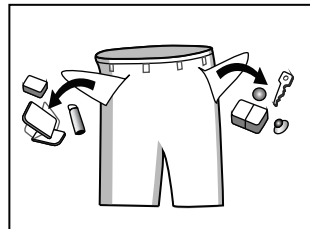

#### For the clothes to be washed, they are classified according to the following characteristics:

The symbol types of care labels: the clothes to be washed are classified into cotton, blended fiber, synthetic fiber, silk, wool and artificial fiber.

## Operate Washing Machine

Color: white and colorful colors shall be identified. All new colorful articles shall be washed in a separate way.

Size: the articles of different sizes are washed together to increase the washing effects.

Sensitivity: soft articles shall be washed separately. As for new pure wool textiles, curtains and silks, the soft washing procedure shall be selected. Check the labels in all washing articles.

The clothes shall be sorted before being put into washing machine. As for the curtains with hooks, the hooks shall be removed before being washed.

The decorations on the clothes may damage the washing machine. As for the clothes with buttons or embroideries, they shall be turned over before being washed.

### Clean up fasteners:

Zips shall be zipped close and buttons or hooks shall be fixed. The loose band or ribbon shall be bound together.



It is suggested to put bras into the pillowslip with zip or buttons sealed to prevent the steel wire from popping out of bras into the drum and damaging the machine.

Especially delicate textiles such as laced curtains, straightjackets, small articles (tight socks, handkerchiefs, ties etc.) shall be put into string bag for washing.

When washing a single big and heavy dress such as Turkish towels, jeans, wadded jackets etc., it may easily cause great eccentricity and give alarm due to great unbalance. Therefore it is suggested to add one or two more clothes to be washed together so that draining can be done smoothly.

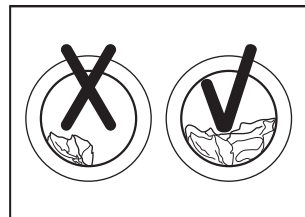
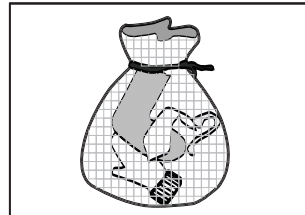

### Clean away dusts, stains and pet hairs from the clothes.

The clothes may be damaged and disturb washing effects during the friction between dusts, stains and clothes.

### To protect baby skin

Baby articles (baby clothes and towels) including napkins shall be washed separately. If they are washed together with the adults' clothes, they may be infected. Rinsing times shall be increased to ensure the thorough rinsing and cleaning without the detergent residues.

**It is suggested that the parts that are easily stained such as white sockets, collars and sleeves etc. shall be hand washed before being put into washing machine to achieve more ideal washing effects.**

Please use powder or liquid detergents. The residues of the soap could remain in the gaps of the clothes if soap is used.

## Operate Washing Machine

Confirm the washing capacity:

Do not put excessive washings; otherwise it may affect the washing effects. Please confirm the maximum affordable washing quantity according to the following table.

Fiber Type	Maximum Loading Capacity
	5.0kg
Cotton	5.0kg
Synthetic	2.5kg
Wool	1.5kg

### **The clothes which easily get fuzzed shall be turned over for washing**

The clothes which easily get fuzzed shall be washed separately; otherwise the other articles can be stained with dust and thrum etc. Preferably, black clothes and cotton clothes shall be washed separately because they can easily get stained with the thrums of other colors when being washed together.

Please check before washing.

### **Washing machine shall not wash water-proof materials (ski suits, outside napkin pads, curtains).**

As for the fiber products that water can not get soaked easily into such as water-proof cushions, and clothes, it is better not to wash. Otherwise there will be water bursting out or abnormal vibration to cause danger while rinsing and draining so that the clothes also may be damaged. (Such as outside napkin pads, raincoats, umbrella, ski suits, car covers, sleeping sacks etc.)

### **Cautions during Draining**

Draining of normal clothes:

Moistures of washings are drained through drain hole.

Draining of water-proof clothes and fiber products:

In the normal washing and draining status, moistures of water-proof clothes and fiber products can not be drained while washing water is gathered in one direction so that the eccentricity of washing machine is too great and vibration or moving is caused.

# Operate Washing Machine

## ■ View of Control Panel

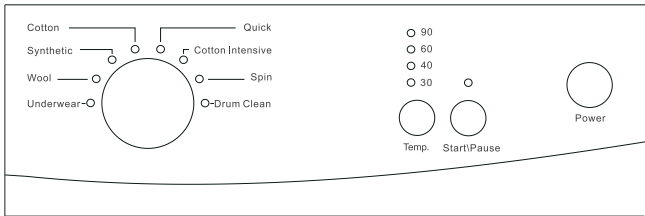

## ■ Rotary Switch Function

There are 8 types of washing selection functions in display. For example:

Cotton: With the corresponding temperature selections: 30 , 40, 60, 90 °C, Cold

Quick: 30 , 40 °C, Cold

Synthetic: 30, 40, 60 °C, Cold

Cotton Intensive: 30 , 40, 60, 90 °C, Cold

Wool: 30, 40 °C, Cold

Spin

Underwear: 30 , 40, 60, 90 °C, Cold

Drum Clean: 90 °C

Cold: When the lights of Temp. (30.40.60.90 °C ) are off means the water temperature is Cold

Notes:

1. The Control panel line chart is for reference only, Please refer to real product as standard.
2. The Control panel could be changed without written notice. Please visit the website of Washing Machine or call up the service line for consultation.

# Operate Washing Machine

## ■ Washing Clothes at first time

Before washing clothes at first time, the washing machine shall be operated in one round of the whole procedures without clothes in as follows:

- 1.Connect power source and water.
- 2.Put a little detergent into the box and close it.
- 3.Press the button "Power".
- 4.Press the button "Start/Pause".

The drawer is separated as follows:

I: Pre-detergent or washing powder.

II: main detergent, softener, pre-dip, bleaching or decontaminating products.

☼ : washing additive, such as fabric softener or tackifier.

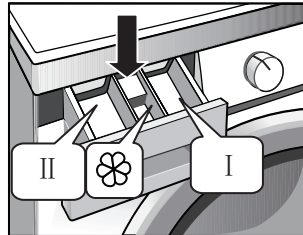

## ■ Put detergent into washing machine.

- 1.Pull out the drawer.
- 2.Fill pre-detergent into Case I (when necessary).
- 3.Fill detergent into Case II.
- 4.Fill softener into Case ☼ (when necessary).

Notes:

As for the agglomerated or ropy detergent or additive, before they are poured into the detergent box, it is suggested to use some water for dilution to prevent the inlet of detergent box from being blocked and overflowing while filling water.

## ■ Start up washing machine

Connect the power. Check if water pipes are connected properly. Open the tap completely. Put in the clothes to be washed and fill in the detergent and tackifier. Then press the button "Power", Select the proper procedures and functions and press the button "Start/Pause".

## ■ Select the procedure

The proper washing procedures shall be selected according to the types, quantities, and dirtiness of the clothes to be washed in combination with the following washing temperature table.

90°C	Seriously besmirched, pure white cotton or flax (for example: coffee table cloths, canteen table cloths, towels, bed sheets)
60°C	Moderately besmirched, colorful flax, cotton and synthetic articles with certain decolorizing degree (for example: shirts, night pajamas; Slightly besmirched, pure white flax (for example: underwear)
40°C, 30°C Cold water	Normally besmirched articles (including synthetic and wool)

## Operate Washing Machine

First, turn the rotary switch to select the corresponding procedures according to the types of textiles.

Second, select the proper temperature according to the dirtiness. Generally, the higher the temperature is, the more the power is consumed.

Last, select the proper revolution speed. The higher the revolution speed is, the drier the textiles are spun, but higher the noises will also be increased.

The surfaces of delicate textiles will have wrinkles and the working life of washing machine will be shortened.

**PLEASE NOTE:** to protect the clothes, the lower revolution speed shall be selected for delicate textiles. The main washing procedures depend on the types of the clothes to be washed.

The main washing troubles can be selected as follows:

### - Cotton

You can select this procedure to wash the daily washable clothes. The washing period is quite long with quite strong washing intensions. It is recommended to wash the daily cotton articles, for example: bed sheets, quilt covers, pillowcases, gowns, underwear etc.

### - Synthetic

You can select this procedure to wash the quite delicate clothes. The procedure is shorter compared with that for cottons and the washing intension is quite gentle. It is recommended to wash synthetic articles, for example: shirts, coats, blending. As for curtains and laced textiles, the procedure "Synthetic" shall be selected. While washing the knitting textiles, detergent quantity shall be reduced due to its loose string construction and easily forming bubbles.

### - Wool

You can select this procedure to wash the wool textiles labeled with "Machine Wash". Please select the proper washing temperature according to the label on the articles to be washed. Furthermore, the proper detergent shall be selected for wool textiles.

### - Underwear

Underwear cycle which is specially made for washing underwears is more demanding on rinsing strength and will operate one more time than other cycles.

### - Quick

This procedure is suitable for washing few and not very dirty clothes quickly.

### - Cotton Intensive

To increase the washing effects, main additional washing time is increased. Except single quick, wash, drain and spin procedures, the other procedures can select Cotton intensive function.

It is recommended to wash the clothes for babies or worn by the persons with allergic skin.

### - Spin

Separate Spin Procedure. Soap water or rinse water shall be drained out before spinning.

### - Drum Clean

This cycle is specially set in this machine to clean the drum and tube. It applies 90 C high temperature sterilization to make the clothes washing more green. When this

## Operate Washing Machine

procedure is performed, the clothes or other washing cannot be added. When proper amount of chlorine bleaching agent is put in, the barrel cleaning effect will be better. The customer can use this procedure regularly according to the need.

### - Bubble Removal Function

Bubble Check Function: Redundant bubbles will occur when there is excessive detergent, which will affect Wash and Rinse effects. The procedure will check automatically and one bubble removal procedure will be added automatically to remove bubbles when excessive bubbles are checked. It will also remind the user to use less detergent during the next similar washes.

### - Suppression of the acoustic signals:

This is an additional buzzer function on your appliance. After deactivating the buzzer function, the buzzer will be closed. After starting the machine, press the "Temp." button for 3 seconds and you will hear a beep, then the buzzer will be closed. To restore the buzzer function, press the "Temp." button again for 3 seconds.

The setting will be kept until the next reset.

Warning: After deactivating the buzzer function, the sounds will not be activated any more before you reset it.

### ■ Table of Washing Procedures

Procedure Description	Load(kg)	Detergent Box			Default Temp.(°C)	Default Time (Min)	Default Speed(rpm)
	5.0	Case I	Case II	Tackifier Case	5.0kg	5.0kg	1000
Quick	1.5		●	○	Cold	15	1000
Cotton Intensive	5.0		●	○	40	140	1000
Spin	5.0		×	×	NA	15	1000
Drum Clean	0		×	×	90	90	500
Cotton	5.0		●	○	60	130	1000
Synthetic	2.5		●	○	40	105	700
Wool	1.5		●	○	40	85	500
Underwear	5.0		●	○	40	108	1000

The energy class is A+

Energy test program: Cotton intensive 60°C /40°C ;

Half load for 5.0Kg machine:2.5Kg.

"Cotton 60°C /40°C +intensive" are the standard washing programs to which the information in the label and the fiche relates, and these programs are suitable to clean normally soiled cotton laundry and that they are the most efficient programs.

- Means must
- Means optional
- ×

Notes: The parameters in this table are only for user's reference. It is difference from the normal time when using depend on the temperature and the load .

## Maintenance

Before your maintenance starts, please do pull out the power plug or disconnect power and close the tap.



**WARNING**

- Solvents are forbidden to avoid that the washing machine is damaged, and toxic gases are generated or exploded.
- Never use water to sprinkle and wash the washing machine.
- It is forbidden that the detergents containing PCMX are used to clean the washing machine.

### ■ Cleaning and Maintenance of Washing Machine Cabinet

Proper maintenance on the washing machine can extend its working life. The surface can be cleaned with diluted non-abrasive neutral detergents when necessary. If there is any water overflow, use the wet cloth to wipe it off immediately. No sharp items are allowed to strike the cabinet.

Notes: formic acid and its diluted solvents or equivalent are forbidden.

### ■ Clean Internal Drum

The rusts left inside the drum by the metal articles shall be removed immediately with chlorine-free detergents.

Never use steel wool.

### ■ Dispose a Frozen Washing Machine

When the temperature drops below zero and your washing machine gets frozen, you may:

1. Disconnect the power supply for the washing machine.
2. Wash the tap with warm water to loosen inlet pipe.
3. Take down inlet pipe and immerse it in warm water.
4. Pour warm water into washing drum and wait for 10 minutes.
5. Reconnect inlet pipe to the tap and check whether inlet and outlet are working normally.

Notes: when the washing machine is reused, make sure the ambient temperature is above 0°C

### ■ Anti-freeze

If your washing machine is located in the room where it can get frozen easily, please drain the remaining water inside drain pipe and inlet pipe thoroughly.

**Remove the remaining water in inlet pipe:**

1. Close the tap.
2. Screw off the inlet pipe from tap and put its end into the container.
3. Start up any procedure except single Wash or Drain procedure. Water will be drained out of inlet pipe if any for about 40 seconds.
4. Reconnect the inlet pipe to tap.

**Remove the remaining water in drain pump**



**WARNING**

To avoid burning, it shall be done after the hot water inside the machine cools down.

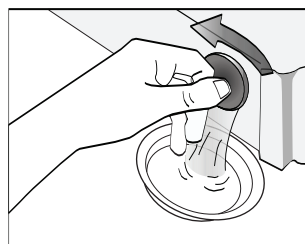



## Maintenance

### ■ Clean detergent box and grooves

Clean detergent drawer and grooves

1. Press down the arrow location on softener cover inside the drawer.
2. Lift the clip up and take out softener cover and wash all grooves with water.
3. Restore the softener cover and push the drawer into position.

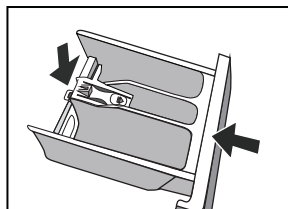
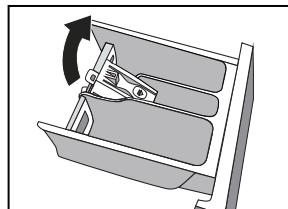
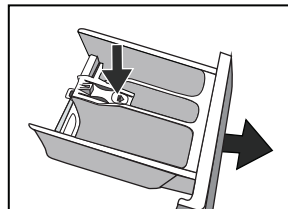

### ■ Clean inlet filter

Inlet filter shall must be cleaned if there is not any or insufficient water in when the tap is opened.

Clean the tap filter:

1. Close the tap.
2. Select any procedure except “Wash” or “Drain” procedure.
3. Press the button “Start/Pause” and keep the procedure running for about 40 seconds.
4. Remove the inlet pipe from the tap.
5. Use water to wash the filter.
6. Reconnect the inlet pipe.

Washing the filter in washing machine:

1. Screw off the inlet pipe from the backside of the machine.
2. Pull out the filter with long nose pliers and reinstall it back after being washed.
3. Reconnect the inlet pipe.
4. Open the tap and make sure there is no water leakage.
5. Close the tap.

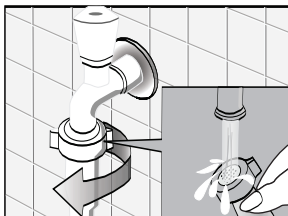

Notes: Generally, the tap filter is washed first and then the filter in washing machine will be washed. If only the filter in washing machine is washed, then the steps 1~3 in cleaning the tap filter shall be repeated.

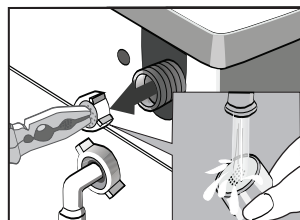
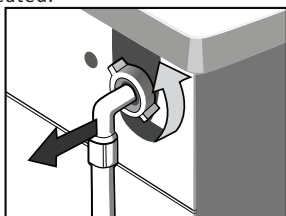

## Maintenance

### WARNING

Pull out the power plug to avoid electrical shock before washing.

After using the washing machine, pull out the power cord and close the door tightly to avoid pinching the kids.

#### ■ Remove foreign matters

##### Drain Pump Filter:

Drain pump filter can filter the yarns and small foreign matters from the washings.

Clean the filter periodically to ensure the normal operation of washing machine.

### WARNING

First, drain the water with drain pump and then open the drain pump to clean away foreign matters from drain pump filter.

Take care if the drained water is hot.

Cleaning the pump

#### Important!

According to the soil level within the cycles and the frequency of the cycles, you have to inspect and clean the filter regularly.

The pump should be inspected if the machine does not empty and/or spin;

the machine makes an unusual noise during draining due to objects such as safety pins, coins etc. blocking the pump.

Proceed as follows:



Open the service panel    Unscrew the pump cover    Screw the pump cover    Close the service panel

- 1 Disconnect the appliance;
- 2 If necessary wait until the water has cooled down.
- 3 Open the service panel .Place a container close to collect any spillage.
- 4 When no more water comes out, unscrew the pump cover and remove it.  
Always keep a rag nearby to dry up spillage of water when removing the cover.
- 5 Remove any objects from the pump impeller by rotating it.
- 6 Screw the pump cover fully in.
- 7 Close the service panel.

#### Waring!

When the appliance is in use and depending on the programme selected there can be hot water in the pump. Never remove the pump cover during a wash cycle, always wait until the appliance has finished the cycle, and is empty. When replacing the cover, ensure it is securely retightend so as to stop leaks and young children being able to remove it.

## Troubleshooting





















Troubles	Reason	Solution
Washing machine cannot start up		Check if the door is closed tightly. Check if power plug is inserted well. Check if water supply tap is opened. Check if button "Start/Pause" is pressed. Check if button "Power" is pressed.
Door cannot be opened	Machine's safety protection design is working.	Disconnect the power.
Heating fault	NTC is damaged and heating pipe is aging.	Can normally wash the clothes. Only cannot wash with heating. Shall contact the service center promptly.
Water leakage	The connection between inlet pipe or outlet hose and tap or washing machine is not tight. Drain pipe in the room is blocked.	Check and fasten water pipes. Clean up outlet hose and ask a specialized person to repair it when necessary.
Water is overflowed from the bottom of the machine	The inlet pipe is not connected firmly. Outlet hose has water leakage.	Fix the inlet pipe. Replace the drain hose.
Indicator or display does not light.	Power is disconnected. PC board has problems. Harness has connection problem.	Check if the power is shut down and power plug is connected correctly. If not, please call up service line.
Detergent residues in the box	Washing powder is dampened and agglomerated.	Clean and wipe the box. Use liquid detergents or the detergents special for drum.
Washing effects are not good	The clothes are too dirty. Insufficient detergent quantity.	Select a proper procedure. Add the proper detergent quantity according to the instructions in <u>detergent package</u> .
Abnormal noise Great vibration		Check if the fixing (bolts) has been removed.If cabinet is installed on the solid and level floor. Check if there are any barrettes or metal articles inside. Check if the legs in the washing machine are adjusted level. See page 6.

## Remove the problems

Status of Corresponding Indicators				Description	Reason	Solution
Temp. 90	Temp. 60	Temp. 40	Temp. 30			
Off	Off	Off	Flash	Door lock problem	Door is not closed properly.	Restart after the door is closed  Please call up service line if there are still troubles.
Off	Flash	Off	Off	Water injecting problem when washing (water injecting time exceeds 5 minutes)	Tap is not opened or water flows too slowly. Inlet valve filter is blocked. Inlet pipe is twisted. If water is not supplied	Open the tap or wait till the water supply becomes normal. Check inlet valve filter. Straighten the water pipe Check the other taps in the room.  Please call up service line if there are still troubles.
Off	Off	Flash	Flash	Drain problem while washing (drain time exceeds 9 minutes)	Outlet hose is blocked or twisted Drain pump is blocked	Wash and straighten outlet hose. Wash drain pump filter  Please call up service line if there are still troubles.
Please call up the service line if there is any other problem.						

## Appendix

### ■ Care Label

Graphic Symbol	Illustration	Graphic Symbol	Illustration
	Hand Wash		No Machine Wash
	Washing (including Machine Wash and Hand Wash)		Do not Wash
	Dry Clean		No Dry Clean
	Warmly Dry Clean		No Wring
	Bleach		No Bleach
	Tumble dry		Do not Tumble Dry
	Iron		Do not Iron
	Steam Iron		Iron with Cloth
	Medium Temperature and Max. Temperature 150 C		Dry after Wash
	Line Dry		Line Dry in Shade

### Electrical Warning

To avoid fire, electrical shock and other accidents, please remember the following reminding:

- Only the voltage indicated in power label can be used. If you are not clear of the voltage at home, please contact the local power bureau.
- When you are using the heating function, the maximum current through the washing machine will reach 10A. Therefore, please make sure the power supply units (current, voltage and cable) can meet the normal load requirements for the machine.
- Protect the power cord properly. Power cord shall be fixed well so that it will not trip the people or other things and be damaged. Special attention shall be paid to the socket. It shall be plugged into the sockets easily and attention shall be paid to the plug location.
- Do not make the wall-mounted socket overloaded or cable extended. Overloading of the wiring may cause fire or electrical shock. Do not pull out power plug with wet hand.
- To ensure your safety, power plug shall be inserted into an earthed three-pole socket. Carefully check and ensure that your socket is properly and reliably earthed.

## Product Specification

Parameter	
Power Supply	220-240V~/50Hz
Dimension(W*D*H)	595*470*850
Weight	50kg
Maximum Power	2100W
Washing Capacity	5.0kg
Rated Current	10A
Standard Water Pressure	0.05MPa~1MPa

➤ **We decline liability for any damage or accident derived from any use of this product which is not in conformity with the instructions contained in this booklet.**

### ● **CORRECT DISPOSAL OF THIS PRODUCT**



This marking indicates that this product should not be disposed with other household wastes throughout the EU. To prevent possible harm to the environment or human health from uncontrolled waste disposal, recycle it responsibly to promote the sustainable reuse of material resources. To return your used device, please use the return and collection systems or contact the retailer where the product was purchased. They can take this product for environmental safe recycling.