

Washing machine  
Lave-linge  
Wasmachine  
Lavadora

980181 - WT 813 A W566C

INSTRUCTIONS FOR USE	.....02
CONSIGNES D'UTILISATION	.....30
GEBRUIKSAANWIJZINGEN	.....60
INSTRUCCIONES DE USO	.....90

**VALBERG**

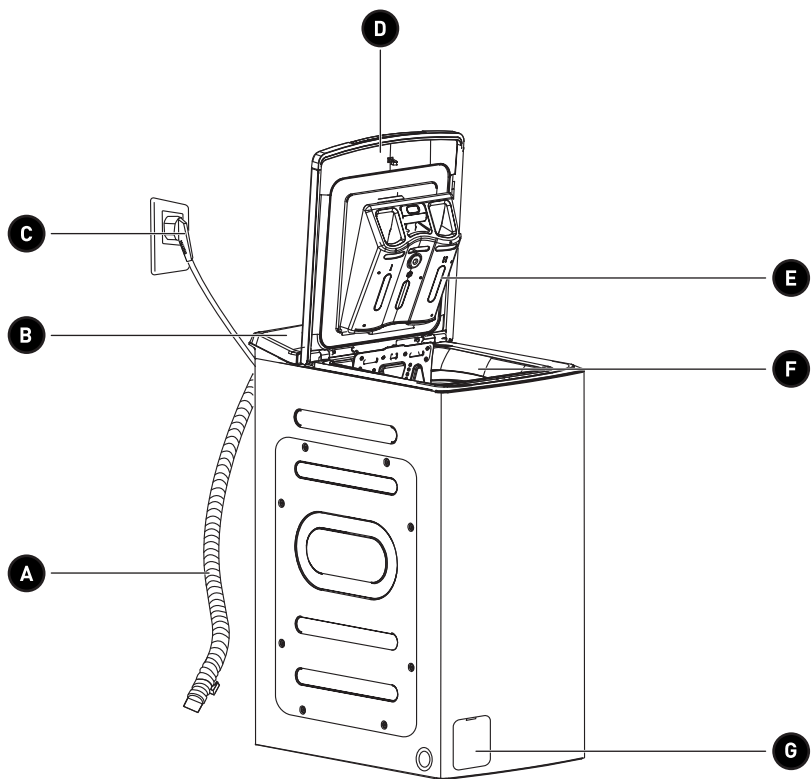

H

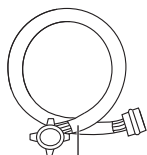

I



J



# Thank you!

Thank you for choosing this VALBERG product. VALBERG products are chosen, tested, and recommended by ELECTRO DEPOT, so you can be sure you are getting a top-quality, easy-to-use product that won't let you down.

We're confident your new device will be a pleasure to use every day!

Welcome to ELECTRO DEPOT.



# Table of Contents

**A**

## **Product overview**

Parts  
Specifications

---

**B**

## **Product usage**

Installation  
Operation

---

**C**

## **Cleaning and maintenance**

Cleaning and maintenance  
Trouble Shooting  
Transport

---

Product Fiche

## Parts

**A** Drain hose

**B** Control panel

**C** Power supply cord

**D** Door

**E** Detergent dispenser

**F** Drum

**G** Service filter

**H** Transport hole plug

**I** Supply hose cold water

**J** Acoustic sponge (Optional)

**Note:**

- The product line chart is for reference only, please refer to real product as standard.

## Specifications

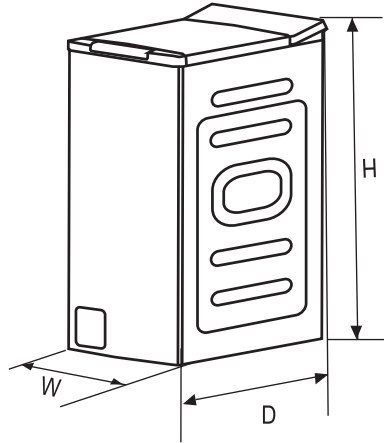

Model:	980181 - WT 813 A W566C
Power Supply:	220-240V~, 50Hz
MAX. Current:	10A
Standard Water Pressure:	0.1MPa ~ 1MPa
Washing Capacity:	8.0kg

### Dimension

W:	400mm
D:	610mm
H:	880mm
Weight:	56kg
Rated Power:	1900W

## Installation

### Installation area

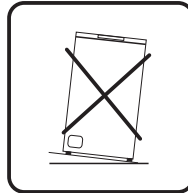
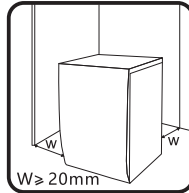

#### Warning!

- Stability is important to prevent the product from wandering!
- Make sure that the product should not stand on the power cord.

Before installing the machine, the location characterized as follows shall be selected:

- Rigid, dry, and level surface
- Avoid direct sunlight
- Sufficient ventilation
- Room temperature is above 0°C
- Keep far away from the heat resources such as coal or gas.

### Unpacking the washing machine

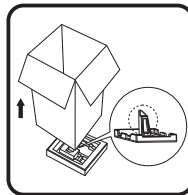

#### Warning!

- Packaging material (e.g. Films, Styrofoam) can be dangerous for children.
- There is a risk of suffocation! Keep all packaging well away from children.

1. Remove the cardboard box and styrofoam packing.
2. Lift the washing machine and remove the base packing. Make sure the small triangle foam is removed with the bottom one together. If not, lay the unit down with side surface, then remove the small foam from the unit bottom manually.
3. Remove the tape securing the power supply cord and drain hose.
4. Remove the inlet hose from the drum.



### Remove transport bolts



#### Warning!

- You must remove the transport bolts from the backside before using the product.
- You'll need the transport bolts again if you move the product, so make sure you keep them in a safe place.

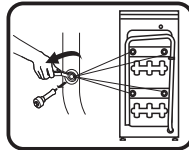

Please take the following steps to remove the bolts:

1. Loosen the 4 transport bolts with a spanner.
2. Remove the bolts including the rubber parts and keep them for future use.
3. Close the holes using the cover caps.

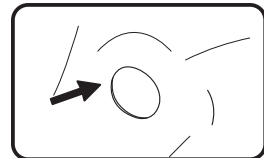
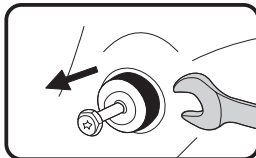
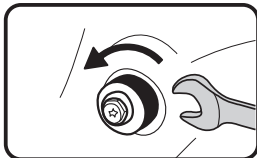

### Levelling the washing machine



#### Warning!

- The lock nuts on all four feet must be screwed tightly against the housing.

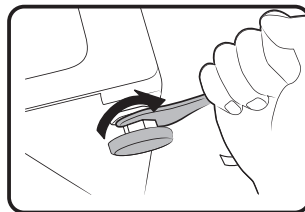

1. Loosen the lock nut.
2. Turn the foot until it reaches the floor.
3. Adjust the legs and lock the nuts with a spanner. Make sure the machine is level and steady.

### Connect the water supply hose



#### Warning!

To prevent leakage or water damage, follow the instructions in this chapter.

- Do not kink, crush or modify water inlet hose.

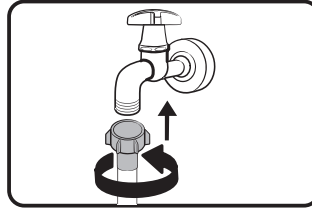
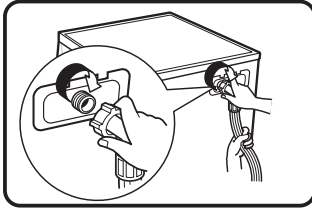

Connect the water supply hose to the water inlet valve and a water tap with cold water as indicated.



#### Note:

- Connect manually, do not use tools. Check if the connections are tight.

### Drain Hose



#### Warning!

- Do not kink or protract the drain hose.
- Position drain hose properly, otherwise damage might result of water leakage.

There are two ways to place the end of drain hose:

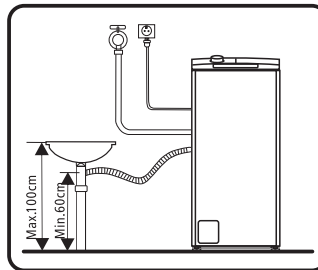
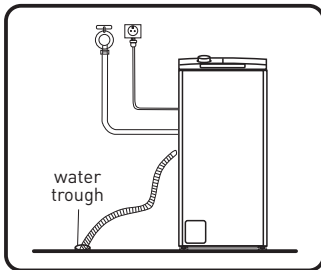

1. Put it into the water trough.
2. Connect it to the branch drain pipe of the trough.



#### Note:

- If the machine has drain hose support, please install it like the following.

## B

## Product usage

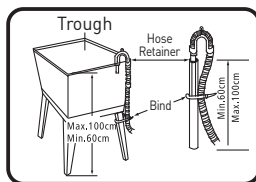
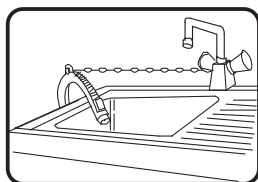

### Warning!

- When installing drain hose, fix it properly with a rope.
- If drain hose is too long, do not force it into washing machine as it will cause abnormal noises.

### Acoustic Sponge



### Note:

- Please make sure to assemble the acoustic sponges, which can effectively reduce the noise caused by the machine while working, in order to provide you with a more peaceful and quiet living environment.

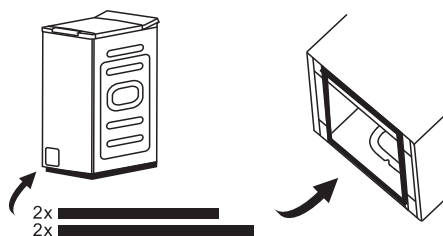

1. Get the machine laid on the floor, using some soft material like foam or clothes between the machine and floor for a protection;
2. Stick the 2x longer sponges to the longer bottom edges of machine, and the 2x shorter sponges to the shorter bottom edges.

## Operation

### Quick Start



### Caution!

- Before washing, please make sure the washing machine is installed properly.
- Your appliance was thoroughly checked before it left the factory. To remove any residual water and to neutralize potential odors, it's recommended to clean your appliance before first use. For this reason, start the Drum Clean without laundry and detergent.

- **Before Washing**

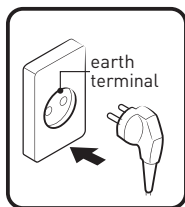

①

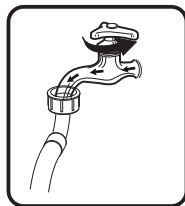

②

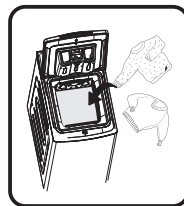

③

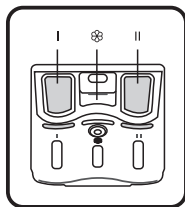

④

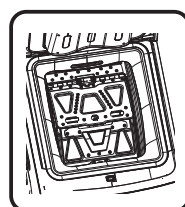

⑤

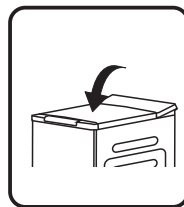

⑥

1. Plug in
2. Open tap
3. Load
4. Add detergent
5. Close drum door
6. Close machine door

**Note:**

- Detergent need to be added in "case I" after selecting pre-washing for machines with this function.
- Make sure that the drum flaps are properly locked.

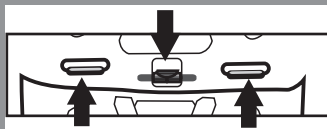

- All metal hooks must be properly hooked inside the rear door flap.

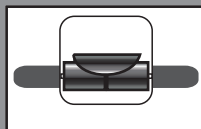

- Check the roller before each laundry, it must roll smoothly.

- **Washing**

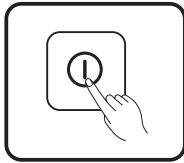

①

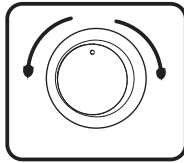

②

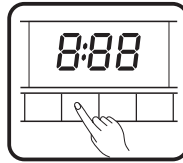

③

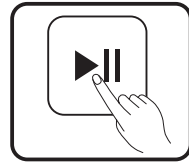

④

1. Power On
2. Select programme
3. Select function or remain default settings
4. Press Start/Pause to start the program

**Note:**

- Step 3 is optional.

- **After Washing**

All lights off.

**Before Each Washing**

- The ambient temperature of the washing machine should be 5-40°C. If used under 0°C, the inlet valve and draining system may be damaged. If the machine is installed under freezing conditions, it should be transferred to normal ambient temperature to ensure the water supply hose and drain hose can unfreeze before use.
- Please check your laundry care labels and the detergent use instructions before wash. Use non-foaming or less-foaming detergent suitable for machine washing properly.

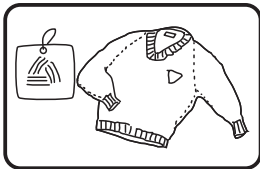

①

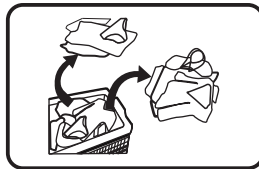

②

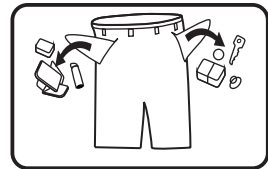

③

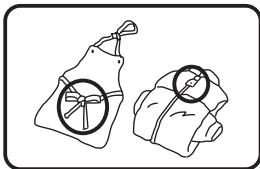

④

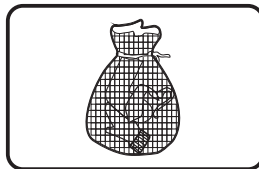

⑤

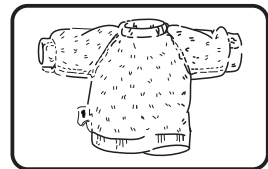

⑥

1. Check the care label

2. Sort laundry according to color and textile type
3. Take all items out of the pockets
4. Tie together long textile strips and belts, close zips and button
5. Put small items into a laundry bag
6. Turn easy-pilling and long-pile fabric inside out



### Warning!

- Do not wash articles that have been cleaned in, washed in, soaked in, or dabbed with combustible or explosive substances like wax, oil, paint, gasoline, alcohol, kerosene, and other flammable materials.
- Washing single clothes items may easily create big eccentricity and cause alarm due to unbalance. Therefore it is suggested to add one or two more laundry items to the wash so that spin can be done smoothly.
- Do not wash, or spin water-proof seats, mats, or clothing.

### Detergent Dispenser

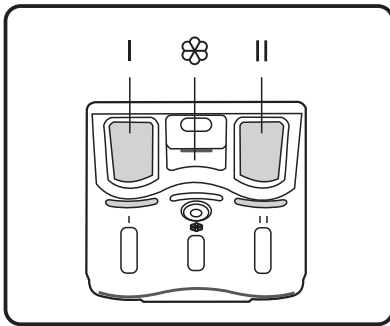

Pull out the dispenser

I Pre Wash detergent

















II Main Wash detergent

 Softener



### Caution!

- Detergent only need to be added in "case I" after selecting pre-washing for machines with this function.
- Do not exceed the "MAX" level mark when filling in detergent, additives or softener.

Programme	I	II	
 Quick 15'		●	○
 Rapid 45'		●	○
 ECO 40-60		●	○
 Steam	○	●	○
 Wool		●	○
 Rinse & Spin			○
 Spin Only			
 Drum Clean			
 Baby Care	○	●	○
 20°C		●	○
 Sportswear	○	●	○
 Jeans	○	●	○
 Mix	○	●	○
 Synthetic	○	●	○
 Cotton	○	●	○

● Means must ○ Means optional

### Detergent Recommendation

Recommended washing detergent	Wash cycles	Washing temp.	Type of laundry and textile
Heavy-duty detergent with bleaching agents and optical brighteners	Cotton, Mix	20/40/60	White laundry made from boil-proof cotton or linen
Colour detergent without bleaching agent and optical brighteners	Cotton, Mix	Cold/20/40	Coloured laundry made from cotton or linen
Color or mild detergent without optical brighteners	Synthetic	Cold/20/40	Coloured laundry made from easy care fibres or synthetic materials
Mild washing detergent	Synthetic	20/40	Delicate textiles, silk, viscose
Special wool detergent	Wool	20/40	Wool

**Note:**

- Agglomerating or ropy detergent or additive can be diluted in some water before pouring it into the detergent dispenser, to avoid its inlet to get blocked and thus cause a water overflow.
- Please choose the suitable type of detergent to get a maximum of washing performance and a minimum of water and energy consumption
- To achieve the best cleaning result a proper detergent dosing is important.
- Use a reduced detergent amount if the drum is not filled completely.
- Always adjust the amount of detergent to the water hardness, if your tap water is soft, use less detergent.
- Dose according to how dirty your laundry is, less dirty clothes require less detergent.
- Highly concentrated (compact detergent) requires particularly accurate dosing.

Following symptoms are a sign of detergent overdosing:

- heavy foam formation
- poor washing and rinsing result

Following symptoms are a sign of detergent underdosing:

- laundry turns grey
- built-up of limescale deposits on the drum, the heating element and/or the laundry



Control Panel

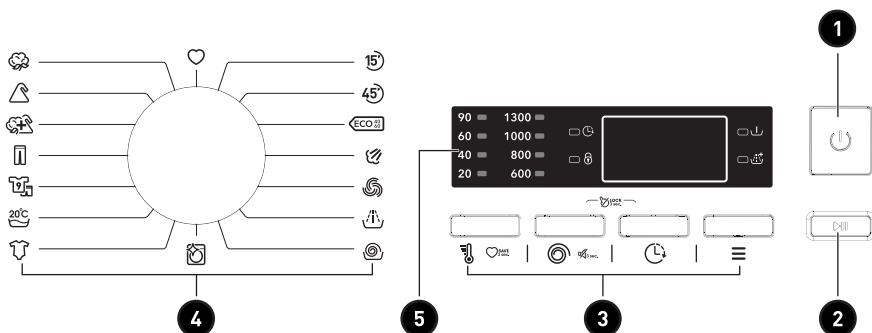

- 1 Power**                      Product is on/off.
- 2 Start/Pause**                Press the button to start or pause the washing cycle.
- 3 Option**                        This allows you to select an additional function.
- 4 Programmes**                Available according to the laundry type.
- 5 Display**                        The display shows the settings, estimated time remaining, options, and status messages for your washer. The display will remain on through the cycle.

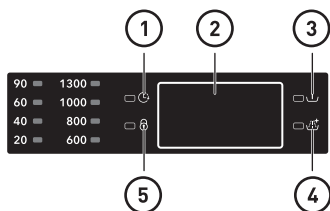

- 1 Delay**
- |                  |            |  |
|------------------|------------|--|
| <b>2 Display</b> |            |  |
| Wash Time        | Delay Time |  |
| 125              | 2H         |  |
| End              | Error      |  |
| End              | E30        |  |
- 3 Pre Wash**

④ Extra Rinse

⑤ Door Lock

### Programmes







Model: WT 813 A W566C

Programme	Load (kg)	Default Time
	8.0	
 Quick 15'	2.0	0:15
 Rapid 45'	2.0	0:45
 ECO 40-60	8.0	3:38
 Steam	4.0	1:47
 Wool	2.0	1:07
 Rinse & Spin	8.0	0:20
 Spin Only	8.0	0:12
 Drum Clean	-	1:18
 Baby Care	8.0	2:01
 20°C	4.0	1:01
 Sportswear	4.0	0:47
 Jeans	8.0	1:40
 Mix	8.0	1:20
 Synthetic	4.0	2:20
 Cotton	8.0	2:40



#### Note:

- The parameters in this table are only for user's reference. The actual parameters may be different with the parameters in above mentioned table.

WT 813 A W566C							
Cycle	Nominal capacity in kg	Temperature setting	Cycle duration in hours and minutes	Energy consumption in kWh/operalling cycle	Water consumption in liter/operalling cycle	Highest temperature °C <sup>(1)</sup>	Residual moisture in %/ spin speed in rpm <sup>(2)</sup>
 Quick 15'	2.0	cold	0:15	0.026	34	cold	53%/800
 ECO 40-60 <sup>(3)</sup>	8.0	--	3:38	0.739	71	38	53.9%/1250
	4.0	--	2:48	0.456	47	32	53.9%/1250
	2.0	--	2:48	0.196	38	23	53.9%/1250
 20°C	4.0	20	1:01	0.183	47	20	70%/800
 Mix	8.0	40	1:20	0.754	44	40	70%/800
 Synthetic	4.0	40	2:20	0.625	34	40	35%/800
 Cotton	8.0	60	2:45	1.394	71	60	53%/1300

- The above data is for reference only, and the data may change due to different actual use conditions.
- The valves given for programmes other than the ECO 40-60 programme are indicative only.
- Compliant to EN 60456: 2016/prA2019 With (EU) 2019/2014, (EU) 2019/2023.  
The EU energy efficiency class is: A  
Energy test program: ECO 40-60. Other as the default.  
Half load for 8.0kg machine: 4.0kg.  
Quarter load for 8.0kg machine: 2.0kg.

<sup>(1)</sup> The highest temperature reached by the laundry in the wash cycle for at least 5 minutes.

<sup>(2)</sup> Residual moisture after the wash cycle in water content percent and the spin speed at which this was achieved.

<sup>(3)</sup> The ECO 40-60 programme is able to clean normally soiled cotton laundry declared to be washable at 40°C or 60°C, together in the same cycle. This programme is used to assess the compliance with the regulation (EU) 2019/2023.

The most efficient programmes in terms of energy consumption are generally those that perform at lower temperatures and longer duration.

Loading the household washer up to the capacity indicated for the respective programmes will contribute to energy and water savings.

Noise and remaining moisture content are influenced by the spinning speed: the higher the spinning speed in the spinning phase, the higher the noise and the lower the remaining moisture content.

















#### Caution!

- If there is any break in the power supply while the machine is operating, a special memory stores the selected programme. The machine will continue the programme when the power supply is re-established.

### Programmes

















































Programmes are available according to the laundry type.

Programmes	
 Quick 15'	Extra short programme approx, suitable for lightly soiled washing as a small amounts of laundry.
 Rapid 45'	Washing few and not very dirty clothes quickly.
 ECO 40-60	Able to clean normally soiled cotton laundry declared to be washable at 40°C or 60°C, together in the same cycle.
 Steam	The Steam Wash can deeply penetrate the fiber, which effectively eliminate bacterias and germs, preventing odors and protecting health.
 Wool	Hand or machine-washable wool or richwool textiles. Especially gentle wash programme to prevent shrinkage, longer programme pauses (textiles rest in wash liquor).
 Rinse & Spin	Rinses and then spins the laundry, and then drains the water.
 Spin Only	Spins and drains the water.
 Drum Clean	Specially set in this machine to clean the drum and tube. It applies 90°C high temperature sterilization to make the clothes washing more green. When this programme is performed, the clothes or other washing cannot be added. When proper amount of chlorine bleaching agent is put in, the barrel cleaning effect will be better. The customer can use this programme regularly according to the need.
 Baby Care	Washing the baby's clothes, it can make the baby's wear cleaner and make the rinse performance better to protect the baby skin.
 20°C	Able to clean lightly soiled cotton laundry, at a nominal temperature of 20°C.
 Sportswear	Washing the activewear.
 Jeans	Specially for jeans.

 Mix	Mixed load consisting of textiles made of cotton and synthetics.
 Synthetic	Wash synthetic articles, for example: shirts, coats, blending. While washing the knitting textiles, detergent quantity shall be reduced due to its loose string construction and easily forming bubbles.
 Cotton	Hard-wearing textiles, heat-resistant textiles made of cotton or linen.

### Option

Model: WT 813 A W566C

Cycle	Default Temp. (°C)	Default spin speed in rpm	Additional functions
Wash cycles		1300	
 Quick 15'	Cold	800	
 Rapid 45'	20	800	 
 ECO 40-60	--	--	
 Steam	40	800	  
 Wool	40	600	 
 Rinse & Spin	--	800	 
 Spin Only	--	800	
 Drum Clean	90	--	
 Baby Care	60	800	  
 20°C	20	800	 
 Sportswear	20	800	  
 Jeans	40	800	  
 Mix	40	800	  
 Synthetic	40	800	  
 Cotton	40	800	  

**Note:**

- For the maximum spin speed, program time, and other details of the ECO 40-60 program, please refer to the content on the Product Fiche page.
- The table shows which cycle offers which options for adjustment. It also indicates if a setting is not available for a program.

**Pre Wash**

The Prewash function can get an extra wash before main wash, it is suitable for washing the dust rises to surface of the clothes; You need to put detergent into the Case (I) when select it.

**Extra Rinse**

The laundry will undergo extra rinse once after you select it.

**Delay**

Set the Delay function:

1. Select a programme;
2. Press the Delay button to choose the time 0-24H;
3. Press [Start/Pause] to commence the delay operation



Choose programme



Setting time



Start

Cancel the Delay function:

Press the [Delay] button until the display be 0H. It should be pressed before starting the programme. If the programme already started, should switch off programme to reset a new one.

**Caution!**

- If there is any break in the power supply while the machine is operating, a special memory stores the selected programme and when the power is restarted, the program will continue.

**Temp.**

Press the button to regulate the temperature(Cold, 20°C, 40°C, 60°C, 90°C)

**Spin**

Press the button to change the speed.

1300: 0-600-800-1000-1300

**Child Lock**

To avoid mis operation by children.

**Caution!**

- During the "Child Lock" function is activating, the buzzer will beep, When the buttons are pressed.
- Press the two button 3sec. also to be released the function.
- The "Child Lock" will lock all buttons except Power button.
- Cut off the power supply, the kid's protection is to be released.

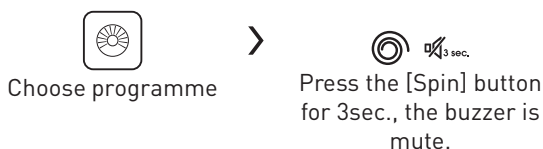
**Mute the buzzer**

To act the buzzer function, press the button again for 3 seconds. The setting will be kept until the next reset.

**Caution!**

- After Muting the buzzer function, the sounds will not be activated any more.

**My Cycle**

To memory the frequently used programme.

After choosing the programme and setting the options, press [Temp.] 3 sec. before start to wash. The default setting course is Cotton.

**Note:**

Usage counter

1. Unplug the equipment for 10s and reconnect again.
2. Power on and within 10s, please press "Temp." and "Function" on control panel simultaneously and continuously for around 5s until the device display shows digits -- the value can indicate the times of equipment usage.
3. Repeat step 1 again and customer can resume to normal operation.

## Cleaning and maintenance



### Warning!

- Before your maintenance starts, please unplug the machine and close the tap.

### Cleaning the Cabinet

Proper maintenance on the washing machine can extend its working life. The surface can be cleaned with diluted non-abrasive neutral detergents when necessary. If there is any water overflow, use the wet cloth to wipe it off immediately. No sharp items are allowed.

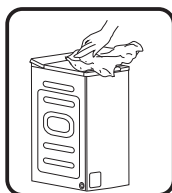

### Note:

- Formic acid and its diluted solvents or equivalent are forbidden, such as alcohol, solvents or chemical products, etc.

### Cleaning the Drum

The rusts left inside the drum by the metal articles shall be removed immediately with chlorine-free detergents. Never use steel wool.



### Note:

- Don't put laundry in the washing machine during the drum cleaning.



## Cleaning the Inlet Filter



### Note:

- Diminishing water flow is a sign that the filter need to be cleaned.

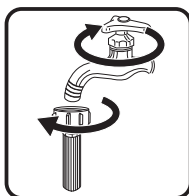

①

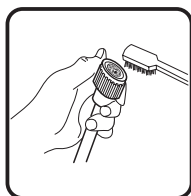

②



③

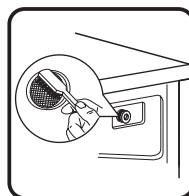

④

1. Close the tap and remove the water supply hose from it.
2. Clean the filter with a brush.
3. Unscrew the water supply hose from the backside of the machine. Pull out the filter with long nose pliers.
4. Use a brush to clean the filter.
5. Reinstall the filter to the water inlet and reconnect the water supply hose.
6. Clean the Inlet filter every 3 months to ensure the normal operation of the appliance.

## Clean The Detergent Dispenser

1. Press down the arrow location on softener cover inside the dispenser drawer.
2. Lift the clip up and take out softener cover and wash all grooves with water.
3. Restore the softener cover and push the drawer onto position.

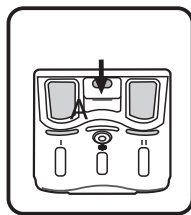

①



②

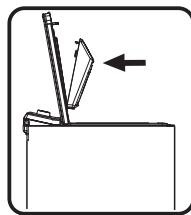

③

1. Pull out the dispenser drawer with press the A.
2. Clean the dispenser drawer under water.
3. Insert the dispenser drawer.

**Note:**

- Do not use abrasive or caustic agents to clean plastic parts.
- Clean the detergent dispenser every 3 months to ensure the normal operation of the appliance.

**Cleaning the Drain Pump Filter****Warning!**

- Make sure that the machine has finished the washing cycle and is empty. Switch it off and unplug it before cleaning the drain pump filter.
- Be careful of hot water. Allow the water to cool down. Risk of scalding!
- Clean the filter periodically every 3 months to ensure the normal operation of the appliance.

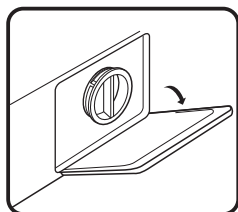

①

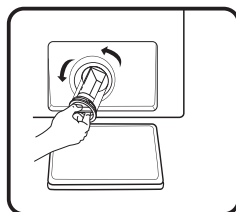

②

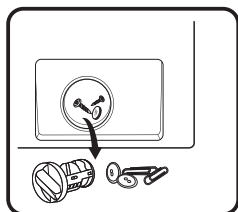

③

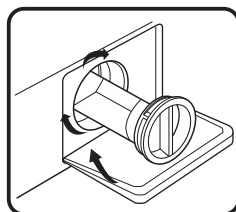

④

1. Open the lower cover cap.

2. Open the filter by turning to the counter clockwise.
3. Remove extraneous matter.
4. Close the lower cover cap.

## Trouble Shooting

The start of the appliance does not work or it stops during operation.  
First try to find a solution to the problem, If not, contact the service centre.

Description	Possible cause	Solution
Washing machine cannot start up	<ul style="list-style-type: none"> <li>• Door is not closed properly</li> </ul>	<ul style="list-style-type: none"> <li>• Restart after the door is closed</li> <li>• Check if the clothes is stuck</li> </ul>
Door can't be opened	<ul style="list-style-type: none"> <li>• Washer's safety protection design is working</li> </ul>	<ul style="list-style-type: none"> <li>• Disconnect the power, restart the product</li> </ul>
Water leakage	<ul style="list-style-type: none"> <li>• The connection between inlet pipe or outlet hose is not tight</li> </ul>	<ul style="list-style-type: none"> <li>• Check and fasten water pipes</li> <li>• Clean up outlet hose</li> </ul>
Detergent residues in the box	<ul style="list-style-type: none"> <li>• Detergent is dampened or agglomerated</li> </ul>	<ul style="list-style-type: none"> <li>• Clean and wipe the detergent box</li> </ul>
Indicator or display does not light	<ul style="list-style-type: none"> <li>• Disconnect the power</li> <li>• PC board or harness has connection problem</li> </ul>	<ul style="list-style-type: none"> <li>• Check if the power is shut down and the power plug is connected correctly</li> </ul>
Abnormal noise	<ul style="list-style-type: none"> <li>• Fixing bolts still in place</li> <li>• Floor is not solid or level</li> </ul>	<ul style="list-style-type: none"> <li>• Check if the fixing (bolts) have been removed</li> <li>• Check it's installed on a solid and level floor</li> </ul>

### LED display models:

E30	<ul style="list-style-type: none"> <li>• Door is not closed properly</li> </ul>	<ul style="list-style-type: none"> <li>• Restart after the door is closed</li> <li>• Check if the clothes is stuck</li> </ul>
E10	<ul style="list-style-type: none"> <li>• Water injecting problem while washing</li> </ul>	<ul style="list-style-type: none"> <li>• Check if the water pressure is too low</li> <li>• Straighten the water pipe</li> <li>• Check if the inlet valve filter is blocked</li> </ul>
E21	<ul style="list-style-type: none"> <li>• Overtime water draining</li> </ul>	<ul style="list-style-type: none"> <li>• Check if the drain hose is blocked</li> </ul>

Description	Possible cause	Solution
E12	<ul style="list-style-type: none"> <li>• Water overflow</li> </ul>	<ul style="list-style-type: none"> <li>• Restart the washer</li> </ul>
EXX	<ul style="list-style-type: none"> <li>• Others</li> </ul>	<ul style="list-style-type: none"> <li>• Please try again first, call up service line if there are still troubles</li> </ul>

**Note:**

- After the check, activate the appliance. If the problem occurs or the display shows other alarm codes again, contact the service.

**Warning!**

Risk of electric shock

- Never try repair an appliance which is defective or presumed to be defective. You may put your own and future users' lives in danger. Only authorised specialists are allowed to carry out this repair work.
- Improper repair will void the warranty and subsequent damages can't be recognised!

## Transport

### IMPORTANT STEPS WHEN MOVING THE APPLIANCE

- Unplug the appliance and close the water inlet tap.
- Check, if the door and the detergent dispenser are closed properly.
- Remove the water inlet pipe and the outlet hose from the house installations.
- Let the water drain completely from the appliance (see «Maintenance Cleaning the drain pump filter»).
- Important: Re-install the 4 transport bolts in the back of the appliance.
- This appliance is heavy. Transport with care. Never hold any protruding part of the machine when lifting. The machine door cannot be used as a handle.

## Product Fiche

**Supplier's name or trade mark<sup>(a),(c)</sup>:**

**Supplier's address<sup>(a),(c)</sup>:**

**Model identifier<sup>(a)</sup>: WT 813 A W566C**

**General product parameters:**

Parameter	Value		Parameter	Value
Rated capacity <sup>(b)</sup> (kg)	8.0		Dimensions in cm <sup>(a),(c)</sup>	Height 88
				Width 40
				Depth 61
Energy efficiency index <sup>(b)</sup> (EEI <sub>w</sub> )	51.9		Energy efficiency class <sup>(b)</sup>	A <sup>(d)</sup>
Washing efficiency index <sup>(b)</sup>	1.031		Rinsing effectiveness (g/kg) <sup>(b)</sup>	5.0
Energy consumption in kWh per cycle, based on the eco 40-60 programme. Actual energy consumption will depend on how the appliance is used.	0.472		Water consumption in litre per cycle, based on the eco 40-60 programme. Actual water consumption will depend on how the appliance is used and on the hardness of the water.	48
Maximum temperature inside the treated textile <sup>(b)</sup> (°C)	Rated capacity	38	Weighted remaining moisture content <sup>(b)</sup> (%)	53.9
	Half	32		
	Quarter	23		
Spin speed <sup>(b)</sup> (rpm)	Rated capacity	1250	Spin-drying efficiency class <sup>(b)</sup>	B <sup>(d)</sup>
	Half	1250		
	Quarter	1250		
Programme duration <sup>(b)</sup> (h:min)	Rated capacity	3:38	Type	free-standing
	Half	2:48		
	Quarter	2:48		

## Product Fiche

Airborne acoustical noise emissions in the spinning phase <sup>(a)</sup> (dB(A) re 1 pW)	78	Airborne acoustical noise emission class <sup>(b)</sup> (spinning phase)	C <sup>(d)</sup>
Off-mode (W) (if applicable)	0.50	Standby mode (W) (if applicable)	N/A
Delay start (W) (if applicable)	4.00	Networked standby (W) (if applicable)	N/A

### Minimum duration of the guarantee offered by the supplier<sup>(a),(c)</sup>:

<b>This product has been designed to release silver ions during the washing cycle</b>	NO
---	----

### Additional information:

Weblink to the supplier's website, where the information in point 9 of Annex II to Commission Regulation (EU) 2019/2023 (1) is found:

<sup>(a)</sup> this item shall not be considered relevant for the purposes of Article 2(6) of Regulation (EU) 2017/1369.

<sup>(b)</sup> for the eco 40-60 programme.

<sup>(c)</sup> changes to this item shall not be considered relevant for the purposes of paragraph 4 of Article 4 of Regulation (EU) 2017/1369.

<sup>(d)</sup> if the product database automatically generates the definitive content of this cell the supplier shall not enter these data.

- The actual energy consumption will depend on how the appliance is used.
- The actual water consumption will depend on how the appliance is used and on the hardness of the water.
- Delivery of the spare parts within 15 working days after having received the order.

Product Data Sheet concerning (EU) 2019/2014.

The product data sheet for your appliance can be found online.

Go to <https://eprel.ec.europa.eu> and enter the model identifier for your appliance to download the data sheet.

The model identifier for your appliance can be found in the technical specifications section.



# Merci !

Merci d'avoir choisi ce produit VALBERG.  
Choisis, testés et recommandés par ELECTRO DEPOT,  
les produits de la marque VALBERG vous assurent  
une utilisation simple, une performance fiable et  
une qualité irréprochable.  
Grâce à cet appareil, vous savez que chaque utilisation  
vous apportera satisfaction.

Bienvenue chez ELECTRO DEPOT.

Visitez notre site Internet : [www.electrodepot.fr](http://www.electrodepot.fr)  
[www.electrodepot.be](http://www.electrodepot.be)

**VOTRE AVIS COMPTE !**



**PARTAGEZ  
VOTRE EXPERIENCE  
SUR LES PRODUITS**

Parce que votre satisfaction est notre priorité, nous vous proposons  
de donner votre avis sur ce produit. Il sera transmis et analysé par  
nos équipes afin d'améliorer continuellement le produit.

**Donnez votre avis sur <http://www.electrodepot.fr/avis-client>**



**ELECTRO DEPOT**

30

FR



# Table des matières

**A**

**Aperçu de l'appareil**

Pièces  
Caractéristiques

---

**B**

**Utilisation de  
l'appareil**

Installation  
Fonctionnement

---

**C**

**Nettoyage et  
entretien**

Nettoyage et entretien  
Dépannage  
Transport

---

Fiche produit

Les notices sont aussi disponibles sur le site  
<http://www.electrodepot.fr/sav/notices/>  
<http://www.electrodepot.be/fr/sav/notices>

## Pièces

**A** Tuyau de vidange

**F** Tambour

**B** Panneau de commande

**G** Filtre d'entretien

**C** Cordon d'alimentation

**H** Capuchon de trou de transport

**D** Porte

**I** Tuyau d'alimentation en eau froide

**E** Distributeur de lessive

**J** Éponge acoustique (en option)



### Remarque :

- Le tableau de la gamme de produits est fourni à titre de référence uniquement, veuillez vous référer au produit réel en tant que norme.

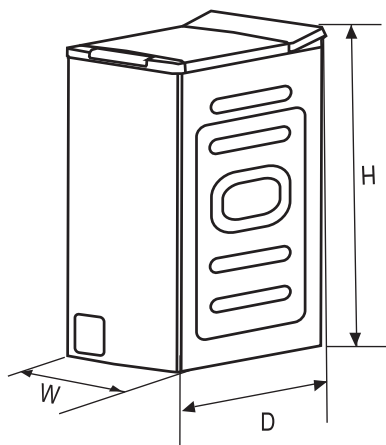
**Caractéristiques**

Modèle :	980181 - WT 813 A W566C
Alimentation électrique :	220-240 V~, 50 Hz
MAX. Courant :	10 A
Pression d'eau standard :	0,1 MPa ~ 1 MPa
Capacité de lavage :	8,0 kg

**Dimension**

Largeur :	400 mm
D :	610 mm
Hauteur :	880 mm
Poids :	56 kg
Puissance nominale :	1 900 W

## Installation

### Zone d'installation

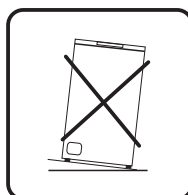
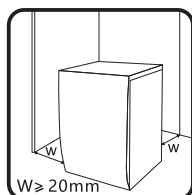

#### Avertissement !

- Il est important que le produit soit stable, car cela l'empêchera de se déplacer !
- Veillez à ce que le produit ne repose pas sur le cordon d'alimentation.

Avant d'installer la machine, sélectionnez un emplacement conforme aux exigences suivantes :

- À la surface ferme, sèche et plane.
- Non exposé à la lumière directe du soleil.
- Suffisamment aéré.
- Avec une température ambiante supérieure à 0 °C.
- Éloigné des sources de chaleur, par exemple les brûleurs à gaz ou au charbon.

### Déballage du lave-linge

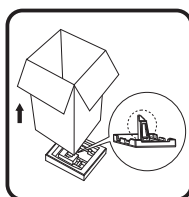

#### Avertissement !

- Les matériaux d'emballage (par ex. : films protecteurs, polystyrène) peuvent représenter un danger pour les enfants.
- Il existe un risque d'étouffement ! Veillez à ce que tous les éléments d'emballage restent hors de portée des enfants.

1. Retirez le carton d'emballage et les éléments en polystyrène.
2. Retirez le lave-linge en le soulevant et retirez l'emballage de la base. Assurez-vous que le petit triangle de mousse est retiré avec la partie inférieure. Si ce n'est pas le cas, posez l'appareil sur le côté, puis retirez manuellement le petit triangle de mousse du fond de l'appareil.

3. Retirez le ruban adhésif fixant le cordon d'alimentation et le tuyau de vidange.
4. Retirez le tuyau d'arrivée du tambour.

### Retirer les vis de transport



#### Avertissement !

- Vous devez retirer les vis de transport au dos du produit avant de l'utiliser.
- Vous aurez à nouveau besoin des boulons de transport si vous déplacez le produit, veillez donc à les conserver en lieu sûr.

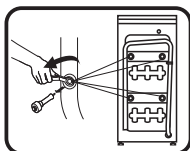

Procédez comme suit pour retirer les vis :

1. Desserrez les 4 vis de transport à l'aide d'une clé.
2. Retirez les vis avec les pièces en caoutchouc et conservez-les pour une utilisation ultérieure.
3. Couvrez les orifices avec les couvercles.

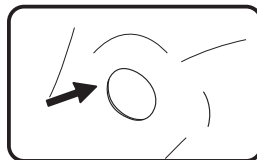
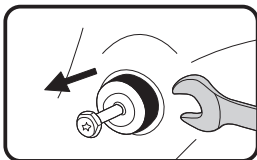
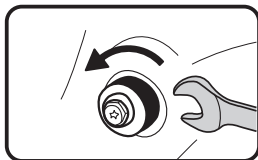

### Mise à niveau du lave-linge



#### Avertissement !

- Les écrous de verrouillage des quatre pieds doivent être serrés fermement contre la paroi.

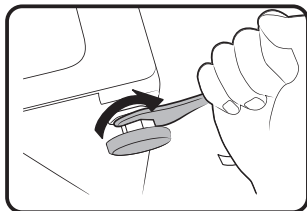

1. Desserrez l'écrou de verrouillage.
2. Faites tourner le pied jusqu'à ce qu'il atteigne le sol.
3. Réglez les pieds et serrez les écrous à l'aide d'une clé. Veillez à ce que la machine soit stable et droite.

### Raccord du tuyau d'arrivée d'eau



#### Avertissement !

Pour éviter une fuite ou des dégâts des eaux, suivez les instructions de ce chapitre.

- Ne pliez pas, n'écrasez pas et ne modifiez pas le tuyau d'arrivée d'eau.

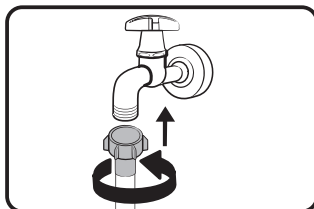
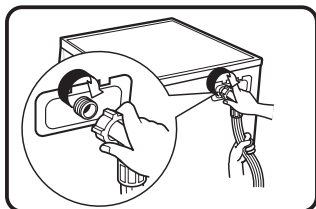

Raccordez le tuyau d'arrivée d'eau à la vanne d'arrivée d'eau et à un robinet d'eau froide comme indiqué.



#### Remarque :

- Le raccordement doit se faire manuellement, sans outils. Vérifiez que les raccords sont étanches.

### Tuyau d'évacuation d'eau



#### Avertissement !

- Ne pliez pas et ne tirez pas le tuyau de vidange.
- Placez correctement le tuyau de vidange pour éviter des dégâts liés à une fuite d'eau.

Le tuyau de vidange peut être positionné de deux manières différentes :

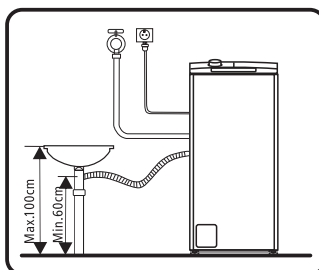
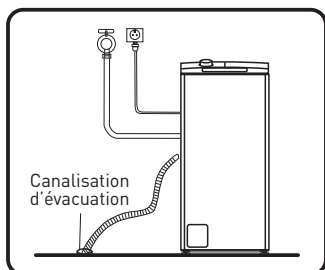

1. Placez-le dans la canalisation d'évacuation des eaux usées.
2. Raccordez-le au tuyau de branchement de la canalisation d'évacuation des eaux usées.



#### Remarque :

- Si l'appareil est pourvu d'un support de tuyau de vidange, veuillez l'installer comme suit.

## B

## Utilisation de l'appareil

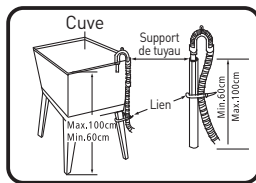
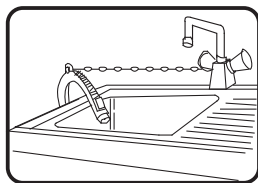

### Avertissement !

- Lors de l'installation du tuyau de vidange, attachez-le avec une corde.
- Si le tuyau de vidange est trop long, ne forcez pas pour l'enfoncer dans le lave-linge, car cela provoquerait des bruits anormaux.

### Éponge acoustique



### Remarque :

- Veillez à assembler la mousse acoustique, qui peut réduire de manière efficace le bruit causé par la machine en fonctionnement et ainsi offrir un environnement de vie plus calme et plus paisible.

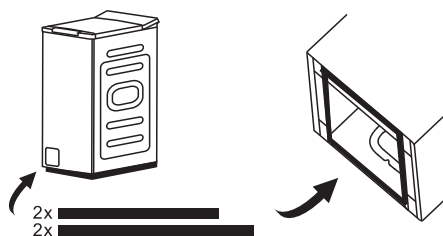

1. Couchez la machine au sol, en la protégeant grâce à un matériau souple posé sur le sol, comme de la mousse ou des vêtements.
2. Collez les 2 bandes de mousse plus longues sur les rebords plus longs de la machine, et les 2 bandes plus courtes sur les rebords plus courts.

## Fonctionnement

### Démarrage rapide



### Attention !

- Avant toute utilisation, assurez-vous que le lave-linge est correctement installé.
- Votre appareil a fait l'objet d'une inspection minutieuse avant son départ de l'usine. Pour éliminer toute eau résiduelle et toute odeur potentielle, il est recommandé de nettoyer l'appareil avant la première utilisation. Pour cette raison, lancez le nettoyage du tambour sans linge ni détergent.

- Avant le lavage

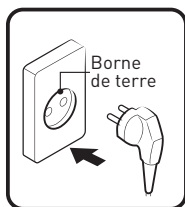

①

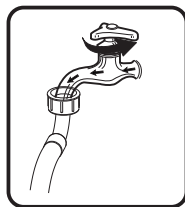

②

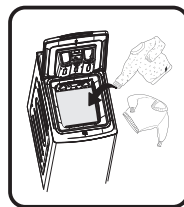

③

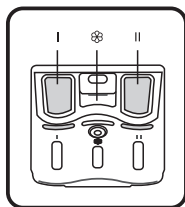

④

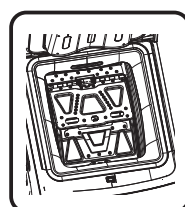

⑤

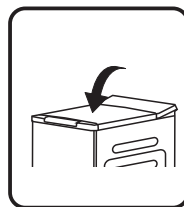

⑥

1. Brancher
2. Ouvrir le robinet
3. Charger
4. Ajouter la lessive
5. Fermer la porte du tambour
6. Fermer la porte de la machine

**Remarque :**

- Le détergent doit être ajouté dans le « compartiment I » après avoir sélectionné le pré-lavage pour les machines dotées de cette fonction.
- Assurez-vous que les volets du tambour sont correctement verrouillés.

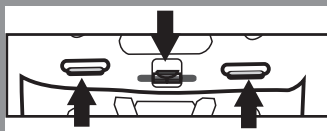

- Tous les crochets métalliques doivent être correctement accrochés à l'intérieur du volet de la porte arrière.



- Vérifiez le rouleau avant chaque lavage, il doit rouler sans problème.



- Lavage**

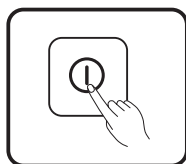

①

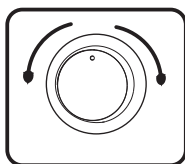

②

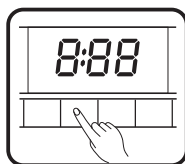

③

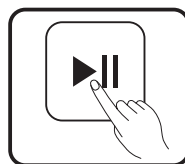

④

1. Mettre en marche
2. Choisir un programme
3. Choisir une fonction ou conserver les réglages par défaut
4. Appuyez sur Démarrer/Pause pour lancer le programme

**Remarque :**

- L'étape 3 est facultative.

- Après le lavage**

Tous les voyants sont éteints.

**Avant chaque lavage**

- La température ambiante doit être comprise entre 5 et 40 °C pour utiliser le lave-linge. S'il est utilisé à une température inférieure à 0 °C, la vanne d'arrivée d'eau et le système de vidange pourraient être endommagés. Si la machine est installée dans des conditions glaciales, elle doit être transférée dans un endroit à la température ambiante normale pour que le tuyau d'arrivée d'eau et le tuyau de vidange puisse dégeler avant l'utilisation.
- Veuillez vérifier les étiquettes d'entretien de votre linge et les consignes d'utilisation de votre lessive avant de commencer un lavage. Utilisez des lessives non moussantes ou peu moussantes adaptées aux lave-linge de façon correcte.

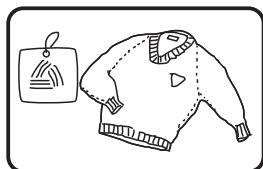

①

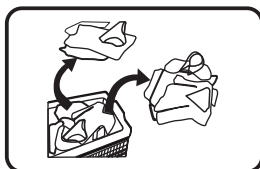

②

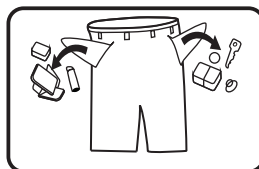

③

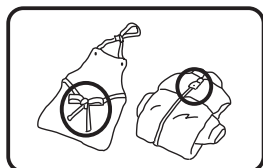

④

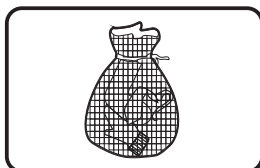

⑤

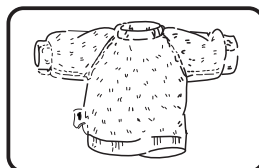

⑥

1. Vérifier l'étiquette d'entretien
2. Trier le linge en fonction des couleurs et du type de textile
3. Retirer tous les objets des poches
4. Nouer les longues bandes de textile et les ceintures, fermer les fermetures éclair et les boutons
5. Placer les petits articles dans un sac à linge
6. Placer les articles s'emmêlant facilement et les tissus à longs poils à l'envers



#### Avertissement !

- Ne lavez pas d'articles ayant été nettoyés, lavés, trempés dans des substances combustibles ou explosives comme de la cire, du pétrole, de la peinture, de l'essence, de l'alcool du kérosène et d'autres matériaux inflammables, ou qui en ont été aspergés.
- Laver un seul article peut facilement créer un déséquilibre important dans le tambour et causer le déclenchement d'une alerte. Il est donc conseillé d'ajouter un ou deux articles supplémentaires pour les laver ensemble, afin de permettre un essorage fluide.
- Ne lavez pas, n'essorez pas et ne séchez pas de housses de siège, tapis ou vêtements imperméables à l'eau.

#### Distributeur de détergent

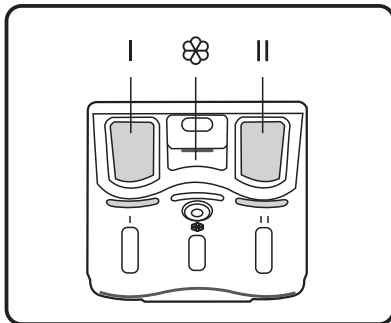

Tirer le distributeur

I Détergent de pré lavage

II Lessive pour le lavage principal

⊗ Adoucissant



#### Attention !

- Le détergent ne doit être ajouté que dans le « compartiment I » après avoir sélectionné le pré lavage pour les machines dotées de cette fonction.
- Ne dépassez pas le niveau « MAX » lorsque vous ajoutez du détergent, des additifs ou de l'adoucissant.

Programme	I	II	☼
Rapide 15'		●	○
Rapide 45'		●	○
ÉCO 40-60		●	○
Vapeur	○	●	○
Laine		●	○
Rinçage et essorage			○
Essorage Seul			
Nettoyage du tambour			
Bébé	○	●	○
20 °C		●	○
Sport	○	●	○
Jean	○	●	○
Mixte	○	●	○
Synthétiques	○	●	○
Coton	○	●	○

● Signifie Obligatoire    ○ Signifie Optionnel

### Recommandations en matière de lessive

Lessive recommandée	Programmes de lavage	Temp. de lavage	Type de linge et textile
Lessive puissante avec agents de blanchiment et azurants optiques	Coton, mixte	20/40/60	Linge blanc composé de coton ou lin résistant aux températures élevées
Lessive pour couleurs sans agents de blanchiment ni azurants optiques	Coton, mixte	Froid/20/40	Lessive colorée composée de coton ou lin
Lessive pour couleurs ou douce sans azurants optiques	Synthétiques	Froid/20/40	Lessive colorée composée de fibres à entretien facile ou de matériaux synthétiques

Lessive douce	Synthétiques	20/40	Textiles délicats, soie, viscose
Lessive spéciale laine	Laine	20/40	Laine



#### Remarque :

- La lessive ou les additifs agglomérants ou fibreux peuvent être dilués dans de l'eau avant d'être versés dans le bac à lessive, afin d'éviter qu'il ne se bloque et n'entraîne un débordement d'eau.
- Veuillez choisir un type de lessive adapté pour obtenir des performances de lavage maximales avec une consommation d'eau et d'électricité minimale.
- Pour bénéficier de résultats de lavage optimaux, il est important de doser correctement la lessive.
- Utilisez une quantité de lessive réduite si le tambour n'est pas complètement rempli.
- Ajustez toujours la quantité de lessive selon la dureté de l'eau. Si votre eau du robinet est douce, utilisez moins de lessive.
- Choisissez la dose selon le degré de saleté du linge. Des vêtements peu sales nécessitent moins de lessive.
- Les lessives à haute concentration (lessives concentrées) requièrent un dosage particulièrement précis.

Voici les signes d'une quantité de lessive excessive :

- Formation de mousse excessive
- Résultats de lavage et de rinçage médiocres

Voici les signes d'une quantité de lessive insuffisante :

- Linge qui devient gris
- Accumulation de dépôts de calcaire sur le tambour, l'élément chauffant et/ou le linge

### Panneau de commande

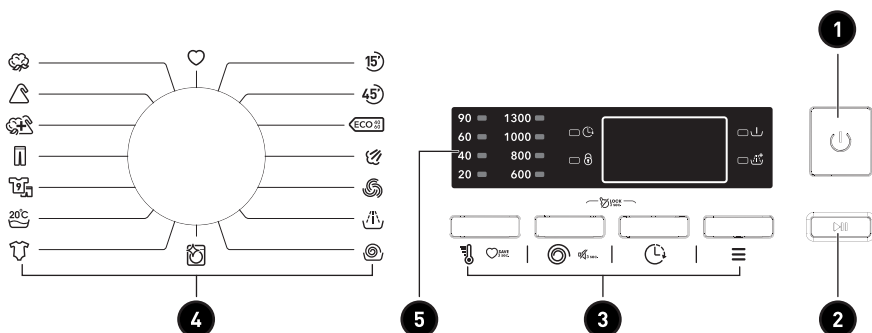

- |                         |  |
|-------------------------|--|
| <b>1 Marche/Arrêt</b>   | Ce bouton permet de mettre l'appareil en marche ou de l'éteindre.  |
| <b>2 Démarrer/Pause</b> | Appuyez sur ce bouton pour démarrer le programme de lavage ou le mettre en pause.  |
| <b>3 Options</b>        | Cette touche vous permet de sélectionner une fonction supplémentaire.  |
| <b>4 Programmes</b>     | Programmes disponibles à la sélection selon le type de linge.  |
| <b>5 Écran</b>          | L'écran affiche les réglages, une estimation du temps restant, les options et les messages d'état de votre lavage. L'écran reste allumé tout au long du cycle. |

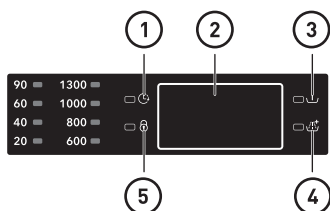















- |          |                 |                |
|----------|-----------------|----------------|
| <b>1</b> | Départ différé  |                |
| <b>2</b> | Écran           |                |
|          | Temps de lavage | Départ différé |
|          | 125             | 2H             |
|          | Fin             | Erreur         |
|          | End             | E30            |

- ③ Prélavage
- ④ Rinçage Plus
- ⑤ Verrou de porte

### Programmes

Modèle : WT 813 A W566C

Programme	Charge (kg)	Durée par défaut
	8,0	
 Rapide 15'	2,0	0:15
 Rapide 45'	2,0	0:45
 ÉCO 40-60	8,0	3:38
 Vapeur	4,0	1:47
 Laine	2,0	1:07
 Rinçage et essorage	8,0	0:20
 Essorage Seul	8,0	0:12
 Nettoyage du tambour	-	1:18
 Bébé	8,0	2:01
 20 °C	4,0	1:01
 Sport	4,0	0:47
 Jean	8,0	1:40
 Mixte	8,0	1:20
 Synthétiques	4,0	2:20
 Coton	8,0	2:40



#### Remarque :

- Les paramètres indiqués dans ce tableau ne sont fournis qu'à titre indicatif. Les réglages réels peuvent différer des paramètres indiqués dans le tableau ci-dessus.

WT 813 A W566C							
Programme	Capacité nominale en kg	Réglage de la température	Durée du programme en heures et minutes	Consommation électrique en kWh/cycle de fonctionnement	Consommation d'eau en litre/cycle de fonctionnement	Température la plus élevée en °C <sup>(1)</sup>	Humidité résiduelle en %/vitesse d'essorage en tr/min <sup>(2)</sup>
15' Rapide 15'	2,0	Froid	0:15	0,026	34	Froid	53 % / 800
	8,0	--	3:38	0,739	71	38	53,9 % / 1250
ECO ÉCO 40-60 <sup>(3)</sup>	4,0	--	2:48	0,456	47	32	53,9 % / 1250
	2,0	--	2:48	0,196	38	23	53,9 % / 1250
20°C	4,0	20	1:01	0,183	47	20	70 %/800
Mixte	8,0	40	1:20	0,754	44	40	70 %/800
Synthétiques	4,0	40	2:20	0,625	34	40	35 % / 800
Coton	8,0	60	2:45	1,394	71	60	53 %/ 1300

- Les données mentionnées ci-dessus sont fournies à titre de référence uniquement et peuvent changer selon les conditions d'utilisation réelles.
- Les données fournies pour les programmes autres que le programme ÉCO 40-60 ne sont données qu'à titre d'indication.
- Conforme à la norme EN 60456 : 2016/prA2019 avec (UE) 2019/2014, (UE) 2019/2023. La classe d'efficacité énergétique européenne est : A  
Programme pour le test d'énergie : ÉCO 40-60. Autre comme programme par défaut.  
Demi-charge pour une machine de 8,0 kg : 4,0 kg.  
Quart de charge pour une machine de 8,0 kg : 2,0 kg.

<sup>1)</sup>La température la plus élevée atteinte par le linge durant le cycle de lavage pendant au moins 5 minutes.

<sup>2)</sup> Humidité résiduelle après le cycle de lavage, en pourcentage de teneur en eau et la vitesse d'essorage à laquelle ce résultat est produit.

<sup>3)</sup> Le programme ÉCO 40-60 est capable de laver du linge en coton normalement sale, pouvant être lavé à 40 °C ou à 60 °C, au cours d'un même cycle. Ce programme est utilisé pour évaluer la conformité au règlement (UE) 2019/2023.

Les programmes les plus efficaces en termes de consommation énergétiques sont généralement ceux qui utilisent des températures plus basses et durent plus longtemps.

Charger un lave-linge domestique jusqu'à la capacité indiquée pour les programmes respectifs contribuera à économiser de l'eau et de l'électricité.

Le bruit et la teneur en humidité restante dépendent de la vitesse d'essorage : plus la vitesse d'essorage est élevée pendant l'essorage, plus le bruit sera élevé et moins il y aura d'humidité restante.











#### Attention !







- En cas de coupure de courant pendant l'utilisation de l'appareil, le programme sélectionné reste dans sa mémoire. La machine reprendra le programme une fois le courant rétabli.

### Programmes

Les programmes sont disponibles à la sélection selon le type de linge.

























Programmes	
 Rapide 15'	Programme extra court d'environ 15 minutes, pour une petite quantité de linge peu sale.
 Rapide 45'	Pour laver rapidement des articles peu nombreux et peu sales.
 ÉCO 40-60	Pour laver du linge en coton normalement sale, pouvant être lavé à 40 °C ou à 60 °C, au cours d'un même cycle.
 Vapeur	Lors du lavage avec vapeur, la vapeur pénètre en profondeur dans les fibres, éliminant de façon efficace les germes et les bactéries, ce qui empêche la formation d'odeurs et protège votre santé.
 Laine	Programme particulièrement doux évitant le rétrécissement des articles. Pauses plus longues pendant le programme (quand les textiles reposent dans l'eau avec la lessive).
 Rinçage et essorage	Pour rincer et essorer le linge, puis évacuer l'eau.
 Essorage Seul	Pour essorer et évacuer l'eau.
 Nettoyage du tambour	Spécialement conçu pour nettoyer le tambour et le tube sur cette machine. Ce programme utilise une stérilisation à une température s'élevant à 90 °C pour rendre le lavage des vêtements plus écologique. Ce programme ne peut pas être lancé avec des vêtements ou autre type de linge. L'effet nettoyant sera plus efficace dans le tambour si une quantité adaptée d'agent de blanchiment au chlore. L'utilisateur peut utiliser ce programme régulièrement selon ses besoins.



 Bébé	Pour laver les vêtements pour bébé. Il nettoie et rince mieux les vêtements afin de protéger la peau des bébés.
 20 °C	Permet de laver le linge en coton légèrement sale à une température nominale de 20 °C.
 Sport	Pour laver les vêtements de sport.
 Jean	Spécialement adapté aux jeans.
 Mixte	Charge mixte, comprenant des textiles composés de coton et de fibres synthétiques.
 Synthétiques	Pour laver les articles synthétiques, par exemple les chemises, les manteaux et les textiles mélangés. Lors du lavage de textiles tricotés, la quantité de lessive doit être réduite à cause de leur structure moins dense entraînant une formation accrue de mousse.
 Coton	Textiles robustes, textiles résistant à la chaleur composés de coton ou de lin.

### Options

Modèle : WT 813 A W566C

Programme	Temp. par défaut (°C)	Vitesse d'essorage par défaut (tr/min)	Fonctions supplémentaires
Programmes de lavage		1300	
 Rapide 15'	Froid	800	
 Rapide 45'	20	800	 
 ÉCO 40-60	--	--	
 Vapeur	40	800	  
 Laine	40	600	 
 Rinçage et essorage	--	800	 
 Essorage Seul	--	800	
 Nettoyage du tambour	90	--	
 Bébé	60	800	  

20 °C	20	800	
Sport	20	800	
Jean	40	800	
Mixte	40	800	
Synthétiques	40	800	
Coton	40	800	



#### Remarque :

- Pour connaître la vitesse d'essorage maximale, la durée du programme et d'autres détails du programme ÉCO 40-60, veuillez vous reporter au contenu de la page de la fiche produit.
- Le tableau indique les options pouvant être réglées pour chaque programme. Il indique également si un paramètre n'est pas disponible pour un programme.



#### Prélavage

La fonction Prélavage permet d'effectuer un lavage supplémentaire avant le lavage principal et convient au lavage de la poussière à la surface des vêtements. Il faut placer de la lessive dans le compartiment (II) lorsque le prélavage est sélectionné.



#### Rinçage Plus

Cette fonction ajoute un rinçage supplémentaire du linge quand cette fonction est sélectionnée.



#### Départ différé

Régler le départ différé :

1. Choisissez un programme.
2. Appuyez sur la touche Départ Différé pour sélectionner 0 à 24h.
3. Appuyez sur la touche Démarrer/Pause pour démarrer le départ différé.



Choisir un programme



Définir la durée



Démarrer

Annuler le départ différé :

Appuyez sur la touche Départ Différé jusqu'à ce que l'écran affiche « 0h ». Appuyez sur cette touche avant de démarrer le programme. Si le programme a déjà commencé, il faut l'arrêter pour en réinitialiser un nouveau.

**Attention !**

- En cas de coupure de courant pendant l'utilisation de l'appareil, le programme sélectionné reste dans sa mémoire. Lorsque le courant est rétabli, le programme reprend.

**Temp.**

Appuyez sur le bouton pour régler la température (froid, 20 °C, 40 °C, 60 °C, 90 °C).

**Essorage**

Appuyez sur le bouton pour changer la vitesse.  
1300 : 0-600-800-1000-1300

**Verrou enfant**

Permet d'éviter toute action accidentelle par des enfants.



Choisir un programme



Démarrer



Appuyez pendant 3 secondes sur les boutons « Essorage » et « Départ différé » jusqu'à ce que la sonnerie retentisse.

**Attention !**

- Lorsque la fonction « Verrouillage sécurité-enfants » est activée, la sonnerie émet un signal sonore lorsque les boutons sont enfoncés.
- Appuyez également sur ces deux boutons pendant 3 secondes pour désactiver cette fonction.
- La fonction « Verrouillage sécurité-enfants » verrouille tous les boutons sauf le bouton [Arrêt].
- En cas de coupure de courant, le verrouillage sécurité-enfants est désactivé lorsque le courant est rétabli.

**Désactivation de la sonnerie**

Choisir un programme



Appuyer sur le bouton [Essorage] pendant 3 secondes : la sonnerie est désactivée.

Pour réactiver la fonction de sonnerie, appuyez à nouveau pendant 3 secondes sur ces boutons. Ce réglage sera conservé jusqu'à la prochaine réinitialisation.

**Attention !**

- Une fois la sonnerie désactivée, toutes les alertes sonores de l'appareil sont désactivées.

**Mon programme**

Pour mémoriser le programme utilisé le plus souvent. Après avoir choisi le programme et réglé les options, appuyez sur le bouton [Temp] pendant 3 secondes avant de démarrer le lavage. Le programme réglé par défaut est Coton.

**Remarque :**

Compteur d'utilisations

1. Débranchez l'appareil pendant 10 secondes, puis rebranchez-le.
2. Mettez-le en marche et, dans les 10 secondes, appuyez en même temps sur les boutons « Temp » et « Fonction » sur le panneau de commande, en les maintenant appuyés pendant environ 5 secondes jusqu'à ce que l'écran de l'appareil affiche des chiffres. Ces chiffres indiquent le nombre d'utilisations de l'appareil.
3. Procédez à nouveau à l'étape 1. L'utilisateur peut alors utiliser l'appareil normalement.

## Nettoyage et entretien



### Avertissement !

- Avant de commencer l'entretien de votre appareil, débranchez le cordon de la prise électrique.

### Nettoyage du corps de l'appareil

L'entretien correct du lave-linge permet de prolonger sa durée de vie. Ses surfaces peuvent être nettoyées avec du détergent neutre non abrasif dilué, si nécessaire. En cas de débordement d'eau, essuyez-la immédiatement avec une serpillière. Aucun objet coupant n'est autorisé.

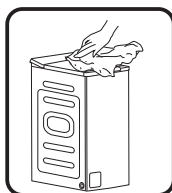

### Remarque :

- L'acide formique et ses solvants dilués ou équivalents sont interdits, tels que l'alcool, les solvants ou les produits chimiques, etc.

### Nettoyage du tambour

La rouille laissée dans le tambour par les articles métalliques doit être enlevée immédiatement avec du détergent non chloré. N'utilisez jamais de laine d'acier.



### Remarque :

- Ne mettez pas de linge dans le lave-linge pendant le nettoyage du tambour.

## Nettoyage du filtre d'arrivée



### Remarque :

- Un flux d'eau réduit indique que le filtre doit être nettoyé.

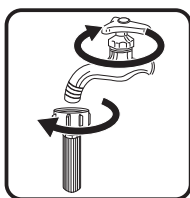

①

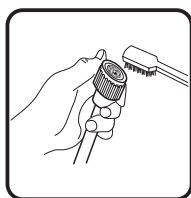

②

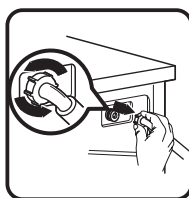

③

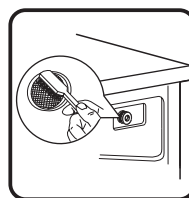

④

1. Fermez le robinet d'eau et déconnectez-en le tuyau d'arrivée d'eau.
2. Nettoyez le filtre à l'aide d'une brosse.
3. Dévissez le tuyau d'arrivée d'eau du dos de la machine. Sortez le filtre avec une pince à long bec.
4. Nettoyez le filtre à l'aide d'une brosse.
5. Remettez le filtre en place au niveau de l'arrivée d'eau et raccordez à nouveau le tuyau d'arrivée d'eau.
6. Nettoyez le filtre d'arrivée tous les 3 mois pour garantir le bon fonctionnement de l'appareil.

## Nettoyage du bac à lessive

1. Appuyez sur l'emplacement de la flèche sur le couvercle de l'adoucissant à l'intérieur du tiroir du distributeur.
2. Relevez le clip et sortez le couvercle à adoucissant, puis lavez tous les compartiments avec de l'eau.
3. Remettez le couvercle de l'adoucissant en place et poussez le tiroir en position.

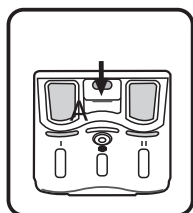

①



②

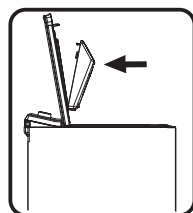

③

1. Retirez le tiroir du distributeur en appuyant sur le bouton A.
2. Nettoyez le tiroir du distributeur sous l'eau.
3. Insérez le bac à lessive.



### Remarque :

- N'utilisez pas de produits abrasifs ou caustiques pour nettoyer les pièces en plastique.
- Nettoyez le bac à lessive tous les 3 mois pour garantir le bon fonctionnement de l'appareil.

## Nettoyage du filtre de la pompe de vidange



### Avertissement !

- Assurez-vous que le programme de lavage est terminé et que la machine est vide. Éteignez la machine et débranchez-la avant de nettoyer le filtre de la pompe de vidange.
- Faites attention à l'eau chaude. Laissez l'eau refroidir. Risque de brûlure !
- Nettoyez le filtre périodiquement tous les 3 mois pour garantir le bon fonctionnement du lave-linge.

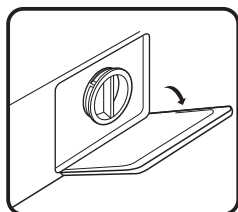

①

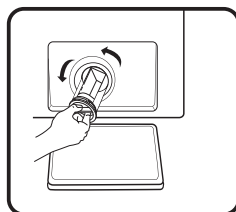

②

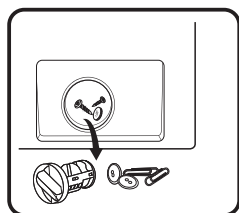

③

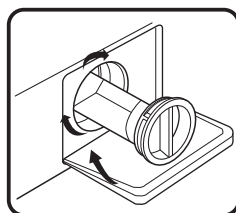

④

1. Ouvrez le couvercle inférieur.
2. Ouvrez le filtre en tournant dans le sens des aiguilles d'une montre.
3. Retirez les corps étrangers.
4. Fermez le couvercle inférieur.

## Dépannage

Le démarrage de l'appareil ne fonctionne pas ou l'appareil s'arrête en cours de fonctionnement. Essayez d'abord de trouver une solution au problème. Si ce n'est pas le cas, contactez le centre d'assistance.

Description	Cause possible	Solution
Le lave-linge ne démarre pas.	<ul style="list-style-type: none"> <li>• La porte n'est pas correctement fermée.</li> </ul>	<ul style="list-style-type: none"> <li>• Redémarrez l'appareil après avoir fermé la porte. Vérifiez si les vêtements sont coincés.</li> </ul>
Impossible d'ouvrir la porte.	<ul style="list-style-type: none"> <li>• Le dispositif de protection du lave-linge est activé.</li> </ul>	<ul style="list-style-type: none"> <li>• Débranchez l'appareil de la prise secteur et remettez-le en marche.</li> </ul>
Il y a une fuite d'eau.	<ul style="list-style-type: none"> <li>• Le raccordement entre le tuyau d'arrivée d'eau ou le tuyau de vidange n'est pas étanche.</li> </ul>	<ul style="list-style-type: none"> <li>• Inspectez et serrez les tuyaux d'eau.</li> <li>• Nettoyez le tuyau de vidange.</li> </ul>
Il y a des résidus de détergent dans le bac.	<ul style="list-style-type: none"> <li>• La lessive est humide ou s'est agglomérée.</li> </ul>	<ul style="list-style-type: none"> <li>• Nettoyez le bac à lessive et séchez-le en l'essuyant.</li> </ul>



Description	Cause possible	Solution
Les voyants ou l'écran ne s'allument pas.	<ul style="list-style-type: none"> <li>• Débranchez l'appareil de la prise secteur.</li> <li>• Il y a un problème de connexion au niveau du circuit imprimé ou du faisceau de fils.</li> </ul>	<ul style="list-style-type: none"> <li>• Vérifiez si l'alimentation électrique est coupée et si la fiche électrique est correctement branchée.</li> </ul>
Bruit anormal	<ul style="list-style-type: none"> <li>• Les vis de blocage sont toujours en place.</li> <li>• Le sol n'est pas ferme ni plat.</li> </ul>	<ul style="list-style-type: none"> <li>• Vérifiez que les vis de blocage ont été retirées.</li> <li>• Assurez-vous que l'appareil est installé sur un sol solide et plat.</li> </ul>

#### Modèle d'affichage des LED :

E30	<ul style="list-style-type: none"> <li>• La porte n'est pas correctement fermée.</li> </ul>	<ul style="list-style-type: none"> <li>• Redémarrez l'appareil après avoir fermé la porte.</li> <li>• Vérifiez si des vêtements sont coincés.</li> </ul>
E10	<ul style="list-style-type: none"> <li>• Problème d'injection d'eau pendant le lavage.</li> </ul>	<ul style="list-style-type: none"> <li>• Vérifiez si la pression de l'eau est trop basse.</li> <li>• Redressez le tuyau d'eau.</li> <li>• Vérifiez si le filtre de la vanne d'arrivée d'eau est bouché.</li> </ul>
E21	<ul style="list-style-type: none"> <li>• Temps de vidange de l'eau excessif.</li> </ul>	<ul style="list-style-type: none"> <li>• Vérifiez si le tuyau de vidange est bouché.</li> </ul>
E12	<ul style="list-style-type: none"> <li>• Débordement d'eau</li> </ul>	<ul style="list-style-type: none"> <li>• Remettez le lave-linge en marche.</li> </ul>
EXX	<ul style="list-style-type: none"> <li>• Divers</li> </ul>	<ul style="list-style-type: none"> <li>• D'abord, essayez à nouveau, puis contactez l'assistance technique si le problème persiste.</li> </ul>



#### Remarque :

- Mettez l'appareil en marche après vérification. Si le problème persiste ou si l'écran affiche à nouveau des codes d'alerte, contactez l'assistance technique.

**Avertissement !**

Risque de choc électrique

- N'essayez jamais de réparer un appareil défectueux ou semblant être défectueux. Vous pourriez mettre votre vie, ainsi que celle des futurs utilisateurs de l'appareil, en danger. Seuls des professionnels agréés sont autorisés à effectuer des travaux de réparation sur cet appareil.
- Une réparation incorrecte annulera la garantie et les dommages en résultant ne seront pas couverts !

**Transport****ÉTAPES IMPORTANTES LORS DU TRANSPORT DE L'APPAREIL**

- Débranchez l'appareil et fermez le robinet d'arrivée d'eau.
- Vérifiez que la porte et le bac à lessive sont bien fermés.
- Retirez le tuyau d'arrivée d'eau et le tuyau de vidange des installations domestiques.
- Laissez l'appareil se vider complètement de l'eau restante (voir le chapitre « Entretien - Nettoyage du filtre de la pompe de vidange »).
- Important : Remettez les 4 vis de transport en place au dos de l'appareil.
- Cet appareil est lourd. Transportez-le avec précaution. Ne tenez jamais une pièce saillante de la machine lorsque vous la soulevez. La porte de l'appareil ne doit pas être utilisée comme une poignée.

## Fiche produit

Nom du fournisseur ou marque de commerce<sup>(a),(c)</sup> :Adresse du fournisseur<sup>(a),(c)</sup> :Identifiant du modèle<sup>(a)</sup> : WT 813 A W566C

## Paramètres généraux du produit :

Paramètre	Valeur		Paramètre	Valeur	
Capacité nominale <sup>(b)</sup> (kg)	8,0		Dimensions en cm <sup>(a),(c)</sup>	Taille	88
				Largeur	40
				Profondeur	61
Indice d'efficacité énergétique <sup>(b)</sup> (EEI <sub>w</sub> )	51,9		Classe d'efficacité énergétique <sup>(b)</sup>	A <sup>(d)</sup>	
Indice d'efficacité de lavage <sup>(b)</sup>	1,031		Efficacité du rinçage (g/kg) <sup>(b)</sup>	5,0	
Consommation électrique en kWh par cycle, basée sur le programme ÉCO 40-60. La consommation électrique réelle dépendra des conditions d'utilisation de l'appareil.	0,472		Consommation d'eau en litres par cycle, basée sur le programme ÉCO 40-60. La consommation d'eau réelle dépendra des conditions d'utilisation de l'appareil et de la dureté de l'eau.	48	
Température maximale à l'intérieur du textile traité <sup>(b)</sup> (°C)	Capacité nominale	38	Teneur en humidité restante pondérée <sup>(b)</sup> (%)	53,9	
	Moitié	32			
	Quart	23			
Vitesse d'essorage <sup>(b)</sup> (tr/min)	Capacité nominale	1250	Classe d'efficacité d'essorage <sup>(b)</sup>	B <sup>(d)</sup>	
	Moitié	1250			
	Quart	1250			
Durée du programme <sup>(b)</sup> (h:min)	Capacité nominale	3:38	Type	Pose libre	
	Moitié	2:48			
	Quart	2:48			

## Fiche produit

Émissions de bruit acoustique aérien pendant la phase d'essorage <sup>(a)</sup> (dB(A) re 1 pW)	78	Classe d'émissions de bruit acoustique aérien <sup>(b)</sup> (phase d'essorage)	C <sup>(d)</sup>
Mode Arrêt (W) (le cas échéant)	0,50	Mode Veille (W) (le cas échéant)	N/A
Départ différé (W) (le cas échéant)	4,00	Veille connectée (W) (le cas échéant)	N/A
<b>Durée minimale de la garantie offerte par le fournisseur<sup>(a),(c)</sup> :</b>			
<b>Ce produit a été conçu pour libérer des ions argent pendant le cycle de lavage.</b>	NON		

### Informations supplémentaires :

Lien web vers le site Internet du fournisseur, où se trouvent les informations du point 9 de l'annexe II du règlement de la Commission (UE) 2019/2023 (1) :

<sup>(a)</sup> Ce produit ne doit pas être considéré comme pertinent aux fins de l'article 2(6) du règlement (UE) 2017/1369.

<sup>(b)</sup> Pour le programme ÉCO 40-60.

<sup>(c)</sup> Les changements apportés à ce produit ne doivent pas être considérés comme pertinents aux fins du paragraphe 4 de l'article 4 du règlement (UE) 2017/1369.

<sup>(d)</sup> Si la base de données du produit génère le contenu définitif de cette cellule de façon automatique, le fournisseur ne doit pas entrer ces données.

- La consommation électrique réelle dépendra des conditions d'utilisation de l'appareil.
- La consommation d'eau réelle dépendra des conditions d'utilisation de l'appareil et de la dureté de l'eau.
- Les pièces de rechange sont livrées dans les 15 jours ouvrables suivant réception de la commande.

Fiche technique du produit relative aux règlements (UE) 2019/2014

La fiche technique de votre appareil peut être consultée en ligne.

Rendez-vous sur <https://eprel.ec.europa.eu> puis entrez l'identifiant du modèle de votre appareil afin de télécharger la fiche technique.

L'identifiant du modèle de votre appareil se trouve dans la section des spécifications techniques.



# Bedankt!

Proficiat met uw keuze voor een product van VALBERG. De selectie en de testen van de toestellen van VALBERG gebeuren volledig onder controle en supervisie van ELECTRO DEPOT. We staan garant voor de kwaliteit van de toestellen van VALBERG, die uitmunten in hun eenvoudig gebruik, hun betrouwbare werking en hun onberispelijke kwaliteit.

ELECTRO DEPOT beveelt de VALBERG toestellen aan en is ervan overtuigd dat u uiterst tevreden zal zijn bij elk gebruik van het toestel. Welkom bij ELECTRO DEPOT.

Bezoek onze website: [www.electrodepot.be](http://www.electrodepot.be)



**ELECTRO DEPOT**

60

NL

# Inhoudstafel

**A**

**Overzicht van het  
toestel**

Onderdelen  
Specificaties

---

**B**

**Gebruik van het  
toestel**

Installatie  
Werking

---

**C**

**Reiniging en  
onderhoud**

Reiniging en onderhoud  
Probleemoplossing  
Transport

---

Productfiche

## Onderdelen

**A** Afvoerslang

**B** Bedieningspaneel

**C** Netsnoer

**D** Deur

**E** Wasmiddellade

**F** Trommel

**G** Servicefilter

**H** Transportgatplug

**I** Toevoerslang koud water

**J** Akoestische spons (optioneel)



### Opmerking:

- De lijngrafiek van het product is alleen ter referentie, raadpleeg het echte product als standaard.

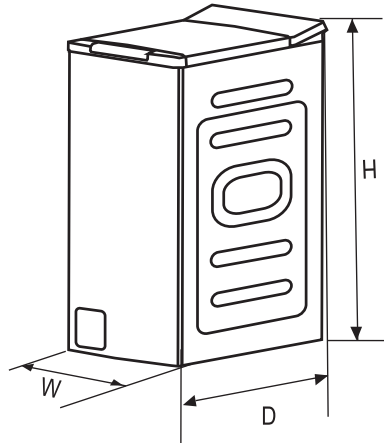

**Specificaties**

Model:	980181 - WT 813 A W566C
Voeding:	220-240 V ~, 50 Hz
MAX. Stroom:	10A
Standaard waterdruk:	0,1 MPa ~ 1 MPa
Wascapaciteit:	8,0 kg

**Afmetingen**

B:	400 mm
D:	610 mm
H:	880 mm
Gewicht:	56 kg
Nominaal vermogen:	1900W

## Installatie

### Installatiegebied

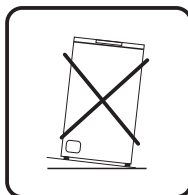
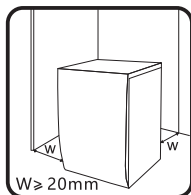

#### Waarschuwing!

- Stabiliteit is belangrijk om het verschuiven van het product te vermijden!
- Zorg ervoor dat het product niet op het snoer staat.

Alvorens de machine te installeren, zoek naar een locatie die aan de volgende eigenschappen voldoet:

- Harde, droge en vlakke ondergrond
- Vermijd direct zonlicht
- Voldoende ventilatie
- Kamertemperatuur is hoger dan 0°C
- Houd uit de buurt van warmtebronnen, zoals verwarmingstoestellen op steenkool of gas.

### De wasmachine uitpakken

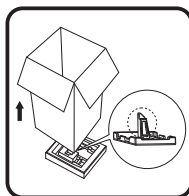

#### Waarschuwing!

- Verpakkingsmateriaal (bijv. folie, piepschuim) kan gevaarlijk zijn voor kinderen.
- Er bestaat verstikkingsgevaar! Houd alle verpakking uit de buurt van kinderen.

1. Verwijder de kartonnen doos en de piepschuimverpakking.
2. Til de wasmachine op en verwijder de basisverpakking. Zorg ervoor dat het kleine driehoekig schuim samen met deze aan de onderkant wordt verwijderd. Als dit niet het geval is, leg het apparaat op zijn zijde en verwijder vervolgens het kleine schuim aan de onderkant van het apparaat met de hand.

3. Verwijder de tape waarmee het netsnoer en de afvoerslang zijn vastgemaakt.
4. Haal de toevoerslang uit de trommel.

### Transportbouten verwijderen



#### Waarschuwing!

- Verwijder de transportbouten aan de achterkant alvorens het product te gebruiken.
- Als je het product verplaatst, heb je de transportbouten weer nodig. Bewaar deze dus op een veilige plek.

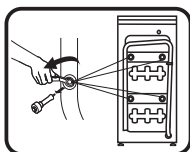

Voer de volgende stappen uit om de bouten te verwijderen:

1. Draai de 4 transportbouten los met een steeksleutel.
2. Verwijder de bouten samen met de rubberen delen en bewaar ze voor toekomstig gebruik.
3. Sluit de gaten met de afdekkappen.

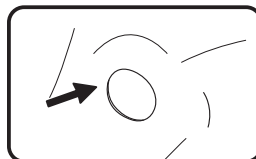
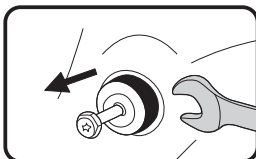
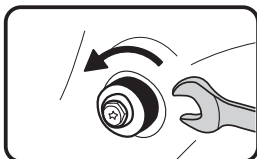

### De wasmachine waterpas zetten



#### Waarschuwing!

- De borgmoeren op alle vier de voeten moeten stevig tegen de behuizing worden vastgeschroefd.

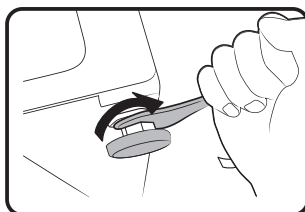

1. Draai de borgmoer los.
2. Draai de voet totdat deze de vloer bereikt.
3. Stel de voeten af en draai de moeren met een steeksleutel vast. Zorg ervoor dat de machine waterpas en stabiel staat.

### De watertoevoerslang aansluiten



#### Waarschuwing!

Volg de instructies in dit hoofdstuk om lekkage of waterschade te voorkomen.

- Zorg dat de watertoevoerslang niet wordt geknikt, geplet of aangepast.

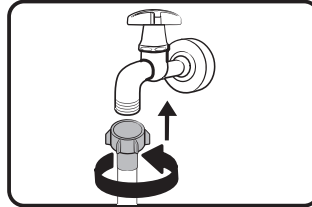
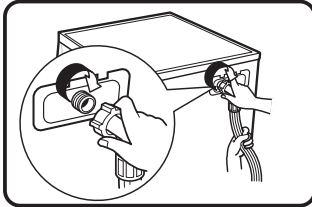

Sluit de watertoevoerslang aan op de waterinlaatklep en een waterkraan met koud water, zoals aangegeven.



#### Opmerking:

- Sluit handmatig aan en gebruik geen gereedschap. Controleer of de verbindingen stevig zijn vastgemaakt.

### Afvoerslang



#### Waarschuwing!

- De afvoerslang niet knikken of verlengen.
- Plaats de afvoerslang op de juiste manier om schade door waterlekkage te vermijden.

Er zijn twee manieren om het uiteinde van de afvoerslang te plaatsen:

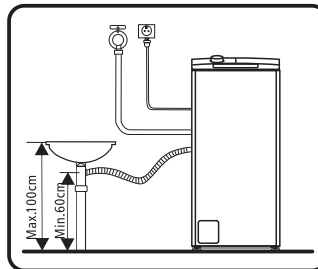
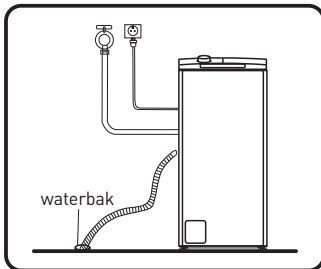

1. Steek de slang in de waterbak.
2. Sluit de slang aan op de afvoerpijp van de bak.



#### Opmerking:

- Als de machine van een afvoerslanghouder is voorzien, installeer deze dan als volgt.

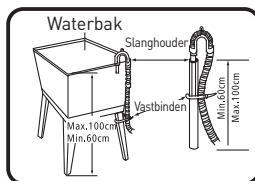
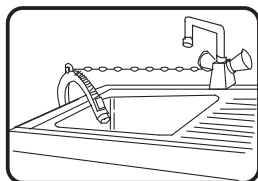
**Waarschuwing!**

- Wanneer u de afvoerslang installeert, maak deze stevig vast met behulp van een koord.
- Als de afvoerslang te lang is, oefen geen druk uit om deze in de wasmachine te duwen, dit zal abnormale geluiden veroorzaken.

**Akoestische sponzen****Opmerking:**

- Zorg ervoor dat u de akoestische sponzen aanbrengt, deze verlagen het geluid van de machine tijdens de werking aanzienlijk om u een rustigere en stillere leefomgeving te bieden.

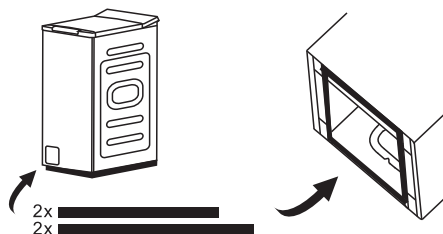

1. Leg de machine op de vloer en breng een zacht materiaal, zoals schuim of doeken, tussen de machine en de vloer aan als bescherming.
2. Plak de 2x langere sponzen op de langere onderste randen van de machine en de 2x kortere sponzen op de kortere onderste randen.

**Werking****Snelle start****Voorzichtig!**

- Controleer voor het wassen of de wasmachine juist geïnstalleerd is.
- Uw apparaat werd grondig gecontroleerd voordat deze de fabriek heeft verlaten. Om eventueel achtergebleven water te verwijderen en mogelijke geuren te neutraliseren, is het raadzaam om uw apparaat voor het eerste gebruik schoon te maken. Start het programma Trommel reinigen zonder wasgoed en wasmiddel.

- Voor het wassen

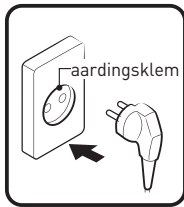

①

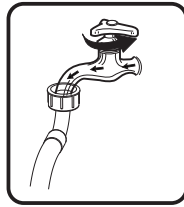

②

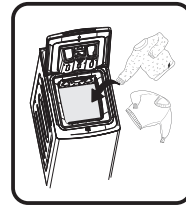

③

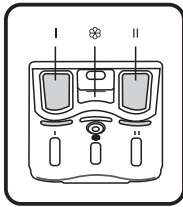

④

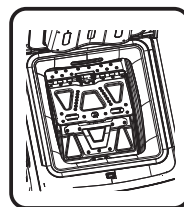

⑤

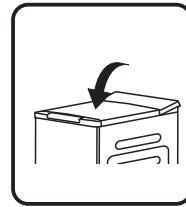

⑥

1. Steek de stekker in het stopcontact
2. Draai de kraan open
3. Vul
4. Voeg wasmiddel toe
5. Sluit de trommeldeur
6. Sluit de machinedeur

**Opmerking:**

- Wasmiddel moet worden toegevoegd in 'vak I' na het selecteren van voorwassen voor machines die met deze functie zijn uitgerust.
- Zorg ervoor dat de trommelkleppen juist vergrendeld zijn.

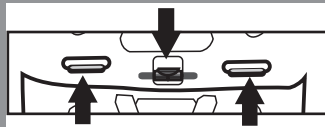

- Alle metalen haken moeten stevig in de klep van de achterste deur vastgehaakt zijn.

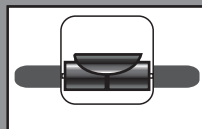

- Controleer de rol voor elke wasbeurt, deze moet soepel rollen.

- **Wassen**

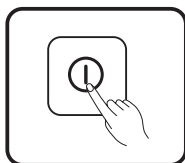

①

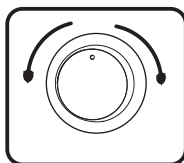

②

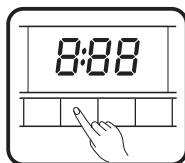

③

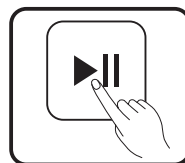

④

1. Schakel de machine in
2. Selecteer het programma
3. Selecteer de functie selecteren of behoud de standaardinstellingen
4. Druk op Start/Pauze om het programma te starten

**Opmerking:**

- Stap 3 is optioneel.

- **Na het wassen**

Alle lichten zijn gedoofd.

**Voor elke wasbeurt**

- De omgevingstemperatuur van de wasmachine moet tussen 5 en 40°C zijn. Bij een gebruik onder 0°C kunnen de inlaatklep en het afvoersysteem beschadigd raken. Als de machine onder vorstomstandigheden wordt geïnstalleerd, moet deze eerst worden overgebracht naar een normale omgevingstemperatuur om ervoor te zorgen dat de watertoevoerslang en afvoerslang voor gebruik kunnen ontdooien.
- Controleer voor het wassen de waslabels en de gebruiksinstructies van uw wasmiddel. Gebruik niet- of beperkt schuimend wasmiddel dat geschikt is voor de wasmachine.

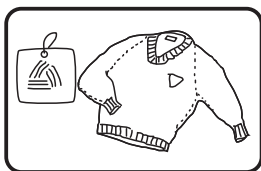

①

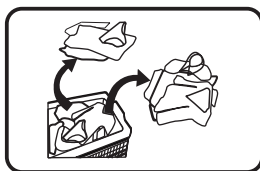

②

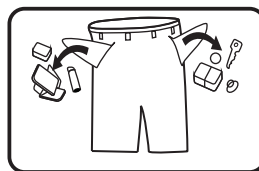

③

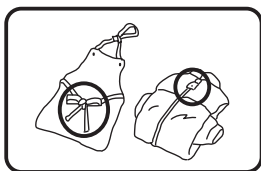

④

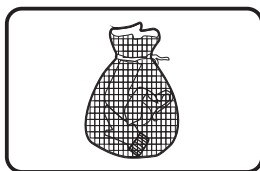

⑤

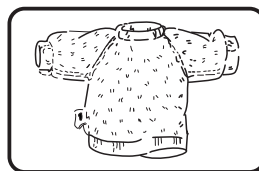

⑥

1. Het waslabel controleren
2. Het wasgoed op kleur en textielsoort sorteren
3. Alle items uit de zakken halen
4. Lange textielstroken en riemen vastmaken, en ritsen en knopen sluiten
5. Kleine items in een waszak stoppen
6. Eenvoudige pluizende en hoogpolige stof binnenstebuiten draaien



#### Waarschuwing!

- Was geen artikelen die zijn gereinigd, gewassen, gedrenkt in of gedept met brandbare of explosieve stoffen zoals was, olie, verf, benzine, alcohol, kerosine en andere brandbare materialen.
- Het wassen van losse kledingstukken kan gemakkelijk een grote excentriciteit veroorzaken en het alarm laten afgaan als gevolg van een onevenwicht. Daarom wordt het aangeraden om nog een of twee extra stukken wasgoed aan de was toe te voegen zodat het centrifugeren soepel verloopt.
- Was of centrifugeer geen waterdichte zittingen, maten of kleding.

#### Wasmiddellade

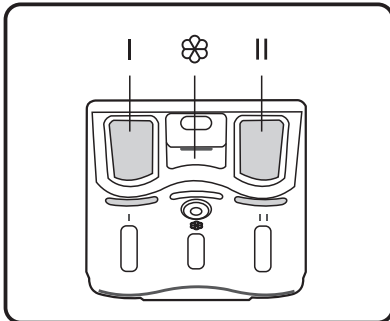

Trek de lade uit

I Wasmiddel voor voorwas

II Wasmiddel voor hoofdwash

















 Wasverzachter



#### Voorzichtig!

- Wasmiddel hoeft alleen te worden toegevoegd in 'vak 1' na het selecteren van voorwassen voor machines die met deze functie zijn uitgerust.
- Overschrijd de markering 'MAX' niet tijdens het vullen van wasmiddel, additieven of wasverzachter.



Programma	I	II	
 Snel 15'		●	○
 Snel 45'		●	○
 ECO 40-60		●	○
 Stoom	○	●	○
 Wol		●	○
 Spoelen en centrifugeren			○
 Alleen centrifuge			
 Trommel reinigen			
 Babyzorg	○	●	○
 20°C		●	○
 Sportkleding	○	●	○
 Jeans	○	●	○
 Gemengd	○	●	○
 Synthetisch	○	●	○
 Katoen	○	●	○

● Betekent moet      ○ Betekent optioneel

#### Aanbeveling voor soort wasmiddel

Aanbevolen wasmiddel	Wascycli	Wastemp.	Soort wasgoed en textiel
Heavy-duty wasmiddel met bleekmiddel en optisch witmiddel	Katoen, gemengd	20/40/60	Witte was van kookvast katoen of linnen
Kleurwasmiddel zonder bleekmiddel en optisch witmiddel	Katoen, gemengd	Koud/20/40	Gekleurd wasgoed van katoen of linnen
Kleur- of mild wasmiddel zonder optisch witmiddel	Synthetisch	Koud/20/40	Gekleurd wasgoed van onderhoudsvriendelijke vezels of synthetisch materiaal
Mild wasmiddel	Synthetisch	20/40	Delicaat stoffen, zijde, viscose
Speciaal wolwasmiddel	Wol	20/40	Wol

**Opmerking:**

- Samengeklonterd of stroperig wasmiddel of additief kan in een beetje water worden verdund voordat het in de wasmiddellade wordt gegoten, om te voorkomen dat de inlaat verstopt raakt en er water overloopt.
- Kies het geschikte soort wasmiddel voor maximale wasprestaties en minimaal water- en energieverbruik.
- Voor het beste reinigingsresultaat is een juiste dosering van het wasmiddel belangrijk.
- Gebruik minder wasmiddel wanneer de trommel niet helemaal gevuld is.
- Pas de hoeveelheid wasmiddel altijd aan naargelang de waterhardheid. Als uw leidingwater zacht is, gebruik dan minder wasmiddel.
- Doseer afhankelijk van hoe vuil uw wasgoed is, voor minder vuile kleding hebt u minder wasmiddel nodig.
- Sterk geconcentreerd (compact) wasmiddel vereist een bijzonder nauwkeurige dosering.

De volgende symptomen zijn een teken van een te grote dosis wasmiddel:

- zware schuimvorming
- slecht was- en spoelresultaat

De volgende symptomen zijn een teken van een te lage dosis wasmiddel:

- wasgoed wordt grijs
- kalkaanslag op de trommel, het verwarmingselement en/of het wasgoed

## Bedieningspaneel

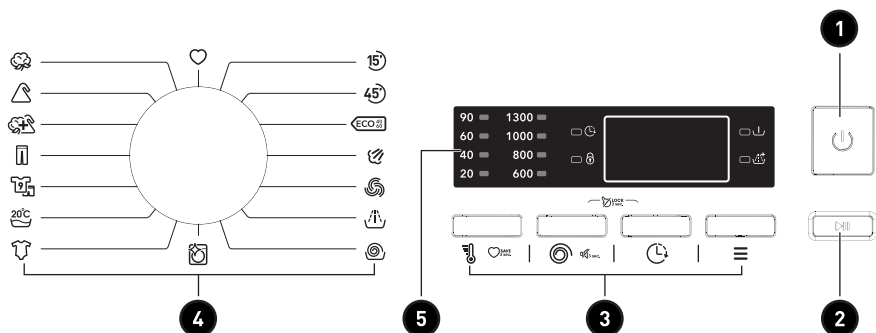

- |          |                    |  |
|----------|--------------------|--|
| <b>1</b> | <b>Aan/uit</b>     | Product is in-/uitgeschakeld.  |
| <b>2</b> | <b>Start/Pauze</b> | Druk op de knop om de wascyclus te starten of te pauzeren.   |
| <b>3</b> | <b>Optie</b>       | Hiermee kunt u een extra functie selecteren.   |
| <b>4</b> | <b>Programma's</b> | Beschikbaar naargelang het soort wasgoed.  |
| <b>5</b> | <b>Display</b>     | Het display toont de instellingen, geschatte resterende tijd, opties en statusmeldingen voor uw wasmachine. Het display blijft tijdens de cyclus ingeschakeld. |

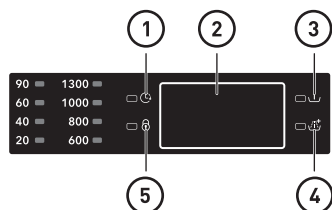















- |          |                |             |
|----------|----------------|-------------|
| <b>1</b> | <b>Uitstel</b> |             |
| <b>2</b> | <b>Display</b> |             |
|          | Wastijd        | Uitsteltijd |
|          | t25            | 2H          |
|          | Einde          | Fout        |
|          | End            | E30         |
| <b>3</b> | <b>Voorwas</b> |             |

④ Extra spoelen

⑤ Deurslot

### Programma's







Model: WT 813 A W566C

Programma	Belasting (kg)	Standaard tijd
	8,0	
 Snel 15'	2,0	0:15
 Snel 45'	2,0	0:45
 ECO 40-60	8,0	3:38
 Stoom	4,0	1:47
 Wol	2,0	1:07
 Spoelen en centrifugeren	8,0	0:20
 Alleen centrifuge	8,0	0:12
 Trommel reinigen	-	1:18
 Babyzorg	8,0	2:01
 20°C	4,0	1:01
 Sportkleding	4,0	0:47
 Jeans	8,0	1:40
 Gemengd	8,0	1:20
 Synthetisch	4,0	2:20
 Katoen	8,0	2:40



#### Opmerking:

- De parameters in deze tabel zijn alleen ter referentie voor de gebruiker. De werkelijke parameters kunnen verschillen met de parameters die in de bovenstaande tabel zijn vermeld.

WT 813 A W566C							
Cyclus	Nominale capaciteit in kg	Temperatuurstelling	Cyclustuur in uren en minuten	Energieverbruik in kWh/bedrijfscyclus	Waterverbruik in liter/bedrijfscyclus	Hoogste temperatuur°C <sup>(1)</sup>	Restvocht in %/centrifugesnelheid in tpm <sup>(2)</sup>
 Snel 15'	2,0	koud	0:15	0,026	34	koud	53%/800
 ECO 40-60 <sup>(3)</sup>	8,0	--	3:38	0,739	71	38	53,9%/1250
	4,0	--	2:48	0,456	47	32	53,9%/1250
	2,0	--	2:48	0,196	38	23	53,9%/1250
 20°C	4,0	20	1:01	0,183	47	20	70%/800
 Gemengd	8,0	40	1:20	0,754	44	40	70%/800
 Synthetisch	4,0	40	2:20	0,625	34	40	35%/800
 Katoen	8,0	60	2:45	1,394	71	60	53%/1300

- De bovenstaande gegevens dienen alleen ter referentie en de gegevens kunnen wijzigen als gevolg van verschillende werkelijke gebruiksomstandigheden.
- De vermelde waarden voor andere programma's dan het programma ECO 40-60 zijn louter indicatief.
- Voldoet aan EN 60456: 2016/prA2019 Met (EU) 2019/2014, (EU) 2019/2023.  
De energie-efficiëntieklasse van de EU is: A  
Energie-testprogramma: ECO 40-60. Andere als het standaard programma.  
Halve lading voor machine van 8,0 kg: 4,0 kg.  
Kwartlading voor machine van 8,0 kg: 2,0 kg.

<sup>(1)</sup> De hoogste temperatuur bereikt door het wasgoed in de wascyclus gedurende minimaal 5 minuten.

<sup>(2)</sup> Restvocht na de wasbeurt in procentuele watergehalte en centrifugesnelheid waarbij dit werd bereikt.

<sup>(3)</sup> Het programma ECO 40-60 is in staat om normaal vervuild katoenen wasgoed dat wasbaar is verklaard op 40°C of 60°C, samen in dezelfde cyclus te wassen. Dit programma wordt gebruikt om de naleving van de verordening (EU) 2019/2023 te beoordelen.

De meest efficiënte programma's in termen van energieverbruik zijn over het algemeen de programma's die goed presteren bij lagere temperaturen en een langere duur.

Door de huishoudelijke wasmachine te vullen tot de capaciteit die is aangegeven voor de respectievelijke programma's, bespaart u op energie en water.

Het lawaai en het resterend vochtgehalte worden beïnvloed door de centrifugesnelheid: hoe hoger de centrifugesnelheid in de centrifugefase, hoe meer lawaai en hoe lager het resterend vochtgehalte.

















### Voorzichtig!

- Als er een stroomonderbreking is terwijl de machine in werking is, dan wordt geselecteerde programma in een speciaal geheugen opgeslagen. De machine gaat door met het programma zodra de stroomvoorziening is hersteld.

### Programma's

































Programma's zijn beschikbaar naargelang het soort wasgoed.

















Programma's	
 Snel 15'	Extra kort programma, geschikt voor het wassen van licht bevuild en een kleine hoeveelheid wasgoed.
 Snel 45'	Weinig en niet erg vuile kleren snel wassen.
 ECO 40-60	Geschikt voor normaal vervuild katoenen wasgoed dat wasbaar is op 40 °C of 60 °C, samen in dezelfde cyclus.
 Stoom	De stoom kan diep in de vezel doordringen, waardoor bacteriën en ziektekiemen effectief worden verwijderd, geurtjes worden voorkomen en uw gezondheid wordt beschermd.
 Wol	Met de hand of in de machine wasbaar textiel (gedeeltelijk) van wol. Zeer zacht wasprogramma om krimpen te voorkomen, langere programmapauzes (textiel rust in het wasmiddel).
 Spoelen en centrifugeren	Spoelt en centrifugeert het wasgoed en laat het water weglopen.
 Alleen centrifuge	Centrifugeert en laat het water weglopen.
 Trommel reinigen	Speciaal programma om de trommel en buis van de machine te reinigen. Het past een sterilisatie op een hoge temperatuur van 90 °C toe om de kleding op een milieuvriendelijkere manier te wassen. Wanneer dit programma wordt uitgevoerd, kunnen er geen kledingstukken of ander wasgoed worden toegevoegd. Wanneer de juiste hoeveelheid chloorbleekmiddel wordt toegevoegd, zal de trommel beter gereinigd worden. De klant kan dit programma regelmatig gebruiken wanneer nodig.
 Babyzorg	Wassen van babykleding om ze schoner te maken en betere spoelprestaties om de babyhuid te beschermen.

 20°C	Kan licht vervuild katoenen wasgoed wassen, bij een nominale temperatuur van 20°C.
 Sportkleding	Sportkleding wassen.
 Jeans	Speciaal voor jeans.
 Gemengd	Gemengde lading bestaande uit textiel van katoen en synthetisch materiaal.
 Synthetisch	Wassen van synthetische artikelen, zoals overhemden, jassen, gemengde stoffen. Tijdens het wassen van breiwerk moet de hoeveelheid wasmiddel worden verminderd vanwege de losse draadconstructie en het gemakkelijk vormen van bellen.
 Katoen	Slijtvast textiel, hittebestendig textiel van katoen of linnen.

**Optie**

Model: WT 813 A W566C

Cyclus	Standaard temp. (°C)	Standaard centrifugesnelheid in tpm	Extra functies
Wascycli		1300	
 Snel 15'	Koud	800	
 Snel 45'	20	800	 
 ECO 40-60	--	--	
 Stoom	40	800	  
 Wol	40	600	 
 Spoelen en centrifugeren	--	800	 
 Alleen centrifuge	--	800	
 Trommel reinigen	90	--	
 Babyzorg	60	800	  
 20°C	20	800	 
 Sportkleding	20	800	  

 Jeans	40	800	  
 Gemengd	40	800	  
 Synthetisch	40	800	  
 Katoen	40	800	  



### Opmerking:

- Voor de maximale centrifugesnelheid, programmatijd en andere details van het ECO 40-60-programma verwijzen wij u naar de inhoud op de Productfiche-pagina.
- De tabel toont u welke cyclus welke instelmogelijkheden biedt. Deze geeft tevens aan of een instelling al dan niet voor een programma beschikbaar is.



### Voorwas

De voorwasfunctie kan een extra wasbeurt krijgen vóór de hoofdwas, deze is geschikt voor het wassen van stof dat naar het oppervlak van de kleding stijgt; Wanneer u dit selecteert, moet u wasmiddel in het bakje (I) doen.



### Extra spoelen

Het wasgoed wordt na het selecteren van deze functie extra gespoeld.



### Uitstel

Stel de vertragingfunctie in:

1. Selecteer een programma;
2. Druk op de uitstelknop om een tijd tussen 0 en 24 uur te kiezen;
3. Druk op [Start/Pauze] om de uitgestelde werking te starten



Programma kiezen



Tijd instellen



Start

De uitstelfunctie annuleren:

Druk op de [Uitstel] knop totdat het display 0H weergeeft. Deze moet worden ingedrukt voordat het programma wordt gestart. Als het programma reeds is gestart, moet u het programma uitschakelen om een nieuw programma in te stellen.



### Voorzichtig!

- Als er een stroomonderbreking is terwijl de machine in werking is, dan wordt geselecteerde programma in een speciaal geheugen opgeslagen en wanneer de stroom terug is, wordt het programma hervat.



**Temp.**

Druk op de knop om de temperatuur te regelen (Koud, 20°C, 40°C, 60°C, 90°C)

**Centrifuge**

Druk op de knop om de snelheid te wijzigen.  
1300: 0-600-800-1000-1300

**Kinderslot**

Om verkeerde bediening door kinderen te voorkomen.



Programma kiezen



Start



Houd [Centrifuge] en [Uitstel] 3 sec. ingedrukt totdat de zoemer afgaat.

**Voorzichtig!**

- Wanneer de 'Kinderslot' functie actief is, gaat de zoemer af wanneer de knoppen worden ingedrukt.
- Houd de twee knoppen tevens 3 sec. ingedrukt om de functie uit te schakelen.
- Het 'Kinderslot' vergrendelt alle knoppen, behalve de Aan/uit-knop.
- Schakel de stroom uit en het kinderslot wordt ontgrendeld.

**De zoemer dempen**

Programma kiezen



Houd de [Centrifuge] knop 3 sec. ingedrukt.  
De zoemer is gedempt.

Om de zoemerfunctie opnieuw te activeren, druk weer 3 seconden op de knop. De instelling blijft behouden tot de volgende terugzetting.

**Voorzichtig!**

- Na het dempen van de zoemerfunctie zijn de geluiden niet langer actief.

**Mijn Cyclus**

Om het vaak gebruikte programma in het geheugen op te slaan. Nadat u het programma hebt gekozen en de opties hebt ingesteld, houd [Temp.] 3 sec. ingedrukt voordat u begint met wassen. De standaardinstelling is Katoen.

**Opmerking:**

Gebruiksteller

1. Haal de stekker 10 seconden uit het stopcontact en steek deze vervolgens weer in het stopcontact
2. Schakel het apparaat in en druk binnen 10 seconden ongeveer 5 seconden tegelijkertijd op 'Temp.' en 'Functie' op het bedieningspaneel totdat het display van het apparaat cijfers -- weergeeft. Deze waarde geeft het aantal gebruiksbeurten van het apparaat weer.
3. Herhaal stap 1 opnieuw en de normale werking wordt hervat.

## Reiniging en onderhoud



### Waarschuwing!

- Voordat u onderhoud op de machine uitvoert, haal de stekker uit het stopcontact en draai de kraan dicht.

### De buitenkant schoonmaken

Een juist onderhoud van de wasmachine kan de levensduur verlengen. De buitenkant kan indien nodig worden gereinigd met een verdund, niet-schurend en neutraal reinigingsmiddel. Als er water overloopt, gebruik dan een vochtige doek om het onmiddellijk weg te vegen. Er zijn geen scherpe voorwerpen toegestaan.

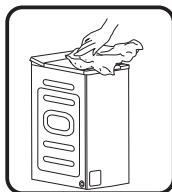

### Opmerking:

- Het gebruik van mierenzuur, verdunde oplosmiddelen of equivalenten ervan zijn verboden, zoals alcohol, oplosmiddelen of chemische producten, etc.

### De trommel schoonmaken

De roest die door de metalen voorwerpen in de trommel achterblijft, moet onmiddellijk worden verwijderd met een chloorvrije schoonmaakmiddel. Gebruik nooit staalwol.



### Opmerking:

- Doe tijdens het programma trommel reinigen geen wasgoed in de wasmachine.

## De inlaatfilter schoonmaken



### Opmerking:

- Een afnemende waterstroom is een teken dat de filter schoongemaakt moet worden.

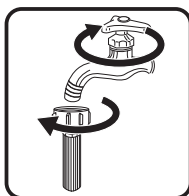

①

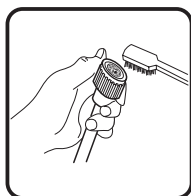

②

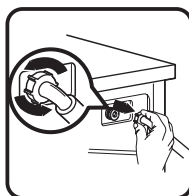

③

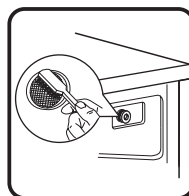

④

1. Draai de kraan dicht en verwijder de watertoevoerslang.
2. Maak de filter schoon met een borstel.
3. Draai de watertoevoerslang los aan de achterkant van de machine. Trek de filter eruit met een platte bektang.
4. Gebruik een borstel om de filter schoon te maken.
5. Plaats de filter terug op de waterinlaat en maak de watertoevoerslang weer vast.
6. Reinig de inlaatfilter elke 3 maanden om een normale werking van het apparaat te garanderen.

## De wasmiddellade schoonmaken

1. Duw de pijl op het wasverzachterklepje in de wasmiddellade omlaag.
2. Breng de clip omhoog, verwijder het wasverzachterklepje en was alle groeven met water.
3. Breng het wasverzachterklepje opnieuw aan en duw de lade op zijn plek vast.

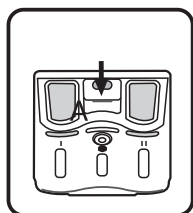

①



②

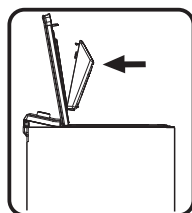

③

1. Trek de wasmiddellade uit door op A te drukken.
2. Maak de wasmiddellade onder de kraan schoon.
3. Plaats de wasmiddellade terug.

**Opmerking:**

- Gebruik geen schurend of bijtend middel om de plastic onderdelen schoon te maken.
- Reinig de wasmiddellade elke 3 maanden om een normale werking van het apparaat te garanderen.

**De filter van de afvoerpomp schoonmaken****Waarschuwing!**

- Zorg ervoor dat de machine de wascyclus heeft beëindigd en leeg is. Schakel de machine uit en haal de stekker uit het stopcontact voordat u de filter van de afvoerpomp reinigt.
- Wees voorzichtig met heet water. Laat het water afkoelen. Gevaar voor brandwonden!
- Maak de filter regelmatig om de 3 maanden schoon om een normale werking van het apparaat te garanderen.

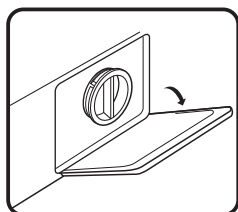

①

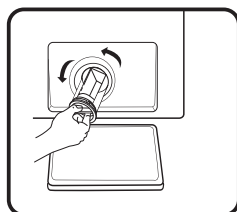

②

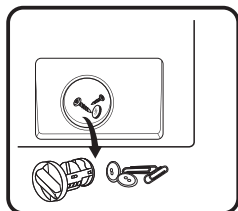

3

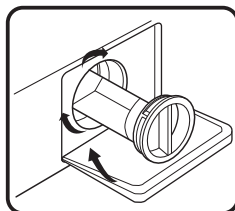

4

1. Open de onderste afdekkap.
2. Open de filter door deze tegen de klok in te draaien.
3. Verwijder vreemde stoffen.
4. Sluit de onderste afdekkap.

## Probleemoplossing

Het apparaat wordt niet ingeschakeld of stopt tijdens de werking.

Probeer eerst een oplossing voor het probleem te vinden. Indien dit niet lukt, neem contact op met het servicecentrum.

Beschrijving	Mogelijke oorzaak	Oplossing
Wasmachine start niet	<ul style="list-style-type: none"> <li>• Deur is niet goed dicht</li> </ul>	<ul style="list-style-type: none"> <li>• Start opnieuw nadat de deur dicht is. Controleer of er geen kleding vastzit</li> </ul>
Deur kan niet worden geopend	<ul style="list-style-type: none"> <li>• De veiligheidsbeveiliging van de wasmachine werd geactiveerd</li> </ul>	<ul style="list-style-type: none"> <li>• Ontkoppel het product van de voeding en start opnieuw</li> </ul>
Waterlekkage	<ul style="list-style-type: none"> <li>• De verbinding tussen de toevoerleiding of de uitlaatslang is niet goed gemaakt</li> </ul>	<ul style="list-style-type: none"> <li>• Controleer en maak de waterleidingen vast</li> <li>• Maak de afvoerslang schoon</li> </ul>
Wasmiddelresten in de lade	<ul style="list-style-type: none"> <li>• Wasmiddel is vochtig of samengeklonterd</li> </ul>	<ul style="list-style-type: none"> <li>• Reinig en veeg de wasmiddellade schoon</li> </ul>
Controlelampje of display licht niet op	<ul style="list-style-type: none"> <li>• Ontkoppel het apparaat van de voeding</li> <li>• Printplaat of kabelboom heeft verbindingproblemen</li> </ul>	<ul style="list-style-type: none"> <li>• Controleer of de netvoeding uitgeschakeld is en de stekker juist in het stopcontact zit</li> </ul>

Beschrijving	Mogelijke oorzaak	Oplossing
Abnormaal geluid	<ul style="list-style-type: none"> <li>• Bevestigingsbouten zitten er nog op</li> <li>• De vloer is niet stevig of vlak.</li> </ul>	<ul style="list-style-type: none"> <li>• Controleer of de bevestigingsbouten zijn verwijderd</li> <li>• Controleer of het apparaat op een stevige en vlakke vloer is geïnstalleerd</li> </ul>

#### Modellen met een LED-display:

E30	<ul style="list-style-type: none"> <li>• Deur is niet goed dicht</li> </ul>	<ul style="list-style-type: none"> <li>• Start opnieuw nadat de deur is gesloten</li> <li>• Controleer of er geen kleding vastzit</li> </ul>
E10	<ul style="list-style-type: none"> <li>• Waterinjectieprobleem tijdens het wassen</li> </ul>	<ul style="list-style-type: none"> <li>• Controleer of de waterdruk te laag is</li> <li>• Maak de waterleiding recht</li> <li>• Controleer of de inlaatklepfilter geblokkeerd is</li> </ul>
E21	<ul style="list-style-type: none"> <li>• Het afvoeren van het water duurt erg lang</li> </ul>	<ul style="list-style-type: none"> <li>• Controleer of de afvoerslang verstopt is</li> </ul>
E12	<ul style="list-style-type: none"> <li>• Er loopt water over</li> </ul>	<ul style="list-style-type: none"> <li>• Schakel de wasmachine opnieuw in</li> </ul>
EXX	<ul style="list-style-type: none"> <li>• Overige</li> </ul>	<ul style="list-style-type: none"> <li>• Probeer het eerst opnieuw en bel de servicelijn als er nog steeds een probleem optreedt</li> </ul>



#### Opmerking:

- Schakel het apparaat in na de controle. Als het probleem optreedt of als het display een andere alarmcode weergeeft, neem contact op met de klantenservice.



#### Waarschuwing!

Risico op elektrische schokken

- Probeer nooit een apparaat te repareren dat (vermoedelijk) defect is. U kunt uw eigen leven en dit van toekomstige gebruikers in gevaar brengen. Alleen geautoriseerde vakmensen mogen deze reparatiewerkzaamheden uitvoeren.
- Een verkeerde reparatie maakt de garantie ongeldig en gevolgschade kan niet worden erkend!

## Transport

### **BELANGRIJKE STAPPEN BIJ HET VERPLAATSEN VAN HET APPARAAT**

- Haal de stekker uit het stopcontact en draai de watertoevoer kraan dicht.
- Controleer of de deur en de wasmiddellade goed gesloten zijn.
- Verwijder de watertoevoerleiding en de afvoerslang van de installaties in uw woning.
- Laat het water volledig uit het apparaat lopen (zie "De filter van de afvoerpomp schoonmaken").
- Belangrijk: Breng de 4 transportbouten opnieuw aan in de achterkant van het apparaat.
- Dit apparaat is zwaar. Wees voorzichtig tijdens het transport. Houd nooit een uitstekend deel van de machine vast tijdens het optillen. De deur van de machine kan niet als handgreep worden gebruikt.



## Productfiche

**Naam of handelsmerk van de leverancier<sup>(a),(c)</sup>:**

**Adres van leverancier<sup>(a),(c)</sup>:**

**Typeaanduiding<sup>(a)</sup>: WT 813 A W566C**

**Algemene productparameters:**

Parameter	Waarde		Parameter	Waarde	
Nominiaal vermogen <sup>(b)</sup> (kg)	8,0		Afmetingen in cm <sup>(a),(c)</sup>	Lengte	88
				Breedte	40
				Diepte	61
Energie-efficiëntie-index <sup>(b)</sup> (EEI <sub>W</sub> )	51,9		Energie-efficiëntieklasse <sup>(b)</sup>	A <sup>(d)</sup>	
Wasefficiëntie-index <sup>(b)</sup>	1,031		Spoeefficiëntie (g/kg) <sup>(b)</sup>	5,0	
Energieverbruik in kWh per cyclus, gebaseerd op het eco 40-60-programma. Het werkelijk energieverbruik hangt af van hoe het apparaat wordt gebruikt.	0,472		Waterverbruik in liter per cyclus, gebaseerd op het eco 40-60-programma. Het werkelijk waterverbruik hangt af van hoe het apparaat wordt gebruikt en van de hardheid van het water.	48	
Maximale temperatuur binnenin het behandelde textiel <sup>(b)</sup> (°C)	Nominale capaciteit	38	Gewogen resterend vochtgehalte <sup>(b)</sup> (%)	53,9	
	Half	32			
	Kwart	23			
Centrifugesnelheid <sup>(b)</sup> (tpm)	Nominale capaciteit	1250	Centrifuge-efficiëntieklasse <sup>(b)</sup>	B <sup>(d)</sup>	
	Half	1250			
	Kwart	1250			
Programmaduur <sup>(b)</sup> (u:min)	Nominale capaciteit	3:38	Type	vrijstaand	
	Half	2:48			
	Kwart	2:48			

## Productfiche

Geluidsemissie via de lucht in de centrifugefase <sup>(a)</sup> (dB(A) re 1 pW)	78	Geluidsemissie via de lucht-klasse <sup>(b)</sup> (centrifugefase)	C <sup>(d)</sup>
Uit-modus (W) (indien van toepassing)	0,50	Stand-bymodus (W) (indien van toepassing)	NVT
Uitgestelde start (W) (indien van toepassing)	4,00	Netwerkgebonden stand-by (W) (indien van toepassing)	NVT
<b>Minimale duur van de door de leverancier geboden garantie<sup>(a),(c)</sup>:</b>			
<b>Dit product is ontworpen om zilverionen tijdens de wascyclus vrij te geven</b>		NEE	

### Extra informatie:

Weblink naar de website van de leverancier, waar de informatie in punt 9 van Bijlage II bij Verordening (EU) 2019/2023 van de Commissie (1) te vinden is:

<sup>a)</sup> dit item wordt niet relevant geacht voor de toepassing van artikel 2(6) van Verordening (EU) 2017/1369.

<sup>b)</sup> voor het eco 40-60-programma.

<sup>c)</sup> wijzigingen in dit item worden niet relevant geacht voor de toepassing van artikel 4, lid 4, van Verordening (EU) 2017/1369.

<sup>d)</sup> als de productendatabank automatisch de definitieve inhoud van deze cel genereert, zal de leverancier deze gegevens niet invoeren.

- Het werkelijk energieverbruik is afhankelijk van hoe het apparaat wordt gebruikt.
- Het werkelijk waterverbruik is afhankelijk van hoe het apparaat wordt gebruikt en van de hardheid van het water.
- Levering van de reserveonderdelen binnen 15 werkdagen na ontvangst van de bestelling.

Productinformatieblad betreffende (EU) 2019/2014

Het productinformatieblad van uw apparaat is online te vinden.

Ga naar <https://eprel.ec.europa.eu> en voer de typeaanduiding voor uw apparaat in om het gegevensblad te downloaden.

De typeaanduiding van uw apparaat vindt u in het gedeelte Technische specificaties.



# ¡Muchas gracias!

Muchas gracias por haber elegido nuestro producto VALBERG. Seleccionados, testados y recomendados por ELECTRO DEPOT, los productos de la marca VALBERG le aseguran una utilización sencilla, un rendimiento fiable y una calidad incuestionable.

Con este dispositivo puede estar seguro de que siempre quedará satisfecho al utilizarlo. Le damos la bienvenida a ELECTRO DEPOT.

Visite nuestra página web: [www.electrodepot.es](http://www.electrodepot.es)



**ELECTRO DEPOT**

90

ES

**A**

**Descripción del  
aparato**

Partes  
Especificaciones

---

**B**

**Utilización del  
aparato**

Instalación  
Funcionamiento

---

**C**

**Limpieza y  
mantenimiento**

Limpieza y mantenimiento  
Solución de problemas  
Transporte

---

Ficha del producto

**Partes****A** Manguera de desagüe**F** Tambor**B** Panel de control**G** Filtro de servicio**C** Cable de alimentación**H** Tapa de agujero para el transporte**D** Puerta**I** Manguera de suministro de agua fría**E** Dispensador de detergente**J** Esponja acústica (opcional)**Nota:**

- El gráfico de líneas del producto se indica solamente como referencia, consulte el producto real como estándar.

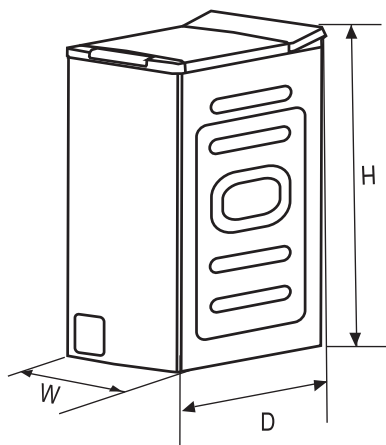
**Especificaciones**

Modelo: 980181 - WT 813 A W566C

Fuente de alimentación: 220-240 V~, 50 Hz

Corriente máx.: 10A

Presión de agua estándar: 0,1 MPa ~ 1 MPa

Capacidad de lavado: 8,0 kg

**Dimensiones**

W: 400 mm

D: 610 mm

H: 880 mm

Peso: 56 kg

Potencia nominal: 1900W

## Instalación

### Zona de instalación

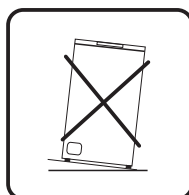
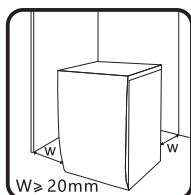

#### ¡Advertencia!

- ¡La estabilidad es importante para evitar que el producto se desplace!
- Asegúrese de que el producto no esté colocado sobre el cable de alimentación.

Antes de instalar la lavadora, se seleccionará la ubicación caracterizada como sigue:

- Superficie rígida, seca y nivelada
- Evite la luz solar directa
- Ventilación suficiente
- Temperatura ambiente superior a 0 °C
- Manténgalo alejado de las fuentes de calor, como el carbón o el gas.

### Desembalar la lavadora

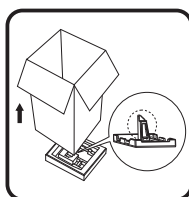

#### ¡Advertencia!

- El material de embalaje (por ejemplo: películas, espuma de poliestireno) puede ser peligroso para los niños.
- ¡Existe riesgo de asfixia! Mantenga todos los materiales de embalaje alejados de los niños.

1. Retire la caja de cartón y el embalaje de espuma de poliestireno.
2. Levante la lavadora y retire el embalaje de la base. Asegúrese de que la espuma triangular pequeña se retire junto con el embalaje inferior. Si no, coloque la unidad con la superficie lateral y luego retire la espuma pequeña de la parte inferior de la unidad manualmente.



3. Retire la cinta que sujeta el cable de alimentación y el tubo de desagüe.
4. Saque la manguera de entrada del tambor.

### Quite los pernos de transporte



#### ¡Advertencia!

- Deberá quitar los pernos de transporte de la parte posterior antes de usar el producto.
- Necesitará los pernos de transporte de nuevo si mueve el producto, así que asegúrese de guardarlos en un lugar seguro.

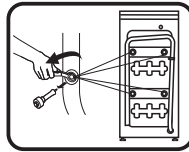

Siga los siguientes pasos para quitar los pernos:

1. Afloje los 4 pernos de transporte con una llave.
2. Retire los pernos, incluyendo las piezas de goma y guárdelos para futuros usos.
3. Cierre los agujeros con las tapas.

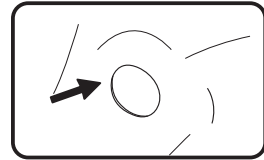
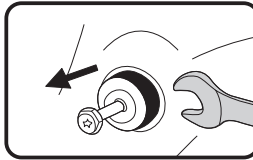
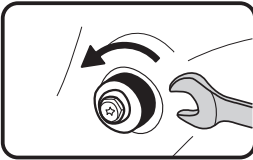

### Nivelar la lavadora



#### ¡Advertencia!

- Las tuercas de bloqueo de las cuatro patas deberán atornillarse firmemente contra la carcasa.

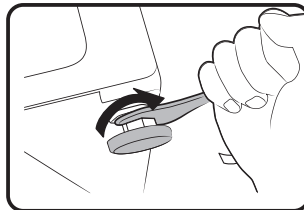

1. Afloje la tuerca de bloqueo.
2. Gire la pata hasta que llegue al suelo.
3. Ajuste las patas y bloquee las tuercas con una llave. Asegúrese de que la lavadora esté nivelada y estable.

**Conecte la manguera de suministro de agua****¡Advertencia!**

Para evitar fugas o daños por agua, siga las instrucciones incluidas en este capítulo.

- No retuerza, aplaste ni modifique la manguera de entrada de agua.

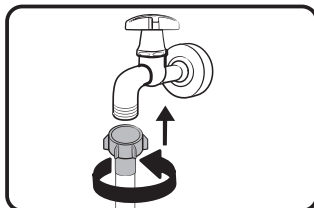
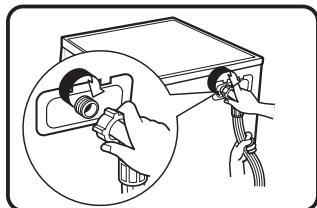

Conecte la manguera de suministro de agua a la válvula de entrada de agua y un grifo de agua fría tal y como se indica.

**Nota:**

- Conéctela manualmente, no use herramientas. Compruebe que las conexiones estén apretadas.

**Tubo de desagüe****¡Advertencia!**

- No retuerza ni alargue el tubo de desagüe.
- Coloque el tubo de desagüe correctamente; de lo contrario, se podrían producir daños por fugas de agua.

Hay dos maneras de colocar el extremo del tubo de desagüe:

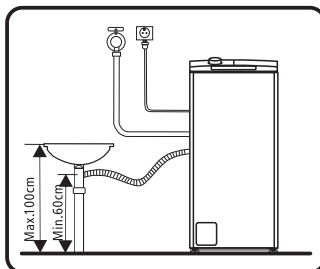
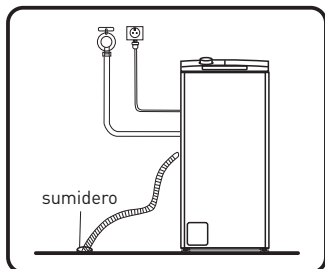

1. Introdúzcalo en el sumidero.
2. Conéctelo a la tubería de desagüe.

**Nota:**

- Si la lavadora tiene un soporte para manguera de drenaje, instálelo de la siguiente manera.

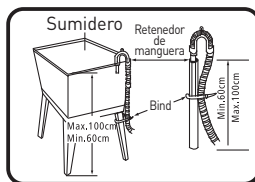
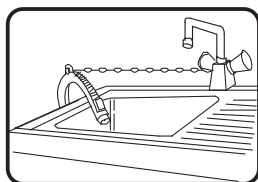

### ¡Advertencia!

- Al instalar la manguera de drenaje, fíjela correctamente con una cuerda.
- Si la manguera de drenaje es demasiado larga, no la introduzca a la fuerza en la lavadora, ya que causará ruidos anormales.

### Esponja acústica



### Nota:

- Asegúrese de montar las esponjas acústicas, que pueden reducir eficazmente el ruido causado por la lavadora durante su funcionamiento, para proporcionarle un ambiente más tranquilo y silencioso.

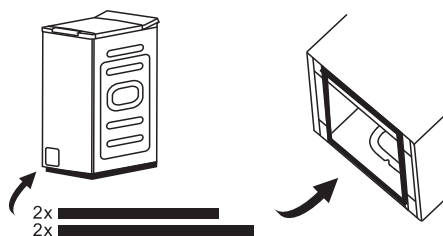

1. Tumbé la lavadora en el suelo, utilizando algún material blando como espuma o ropa entre la lavadora y el suelo para protegerla.
2. Pegue las 2 esponjas más largas en los bordes inferiores más largos de la lavadora; y las 2 esponjas más cortas, en los bordes inferiores más cortos.

## Funcionamiento

### Inicio rápido



### ¡Precaución!

- Antes de lavar, asegúrese de que la lavadora esté instalada correctamente.
- Su aparato fue revisado minuciosamente antes de salir de la fábrica. Para eliminar el agua residual y neutralizar los posibles olores, se recomienda limpiar el aparato antes del primer uso. Para ello, inicie el programa Limpieza del tambor sin ropa ni detergente.

- Antes del lavado



①

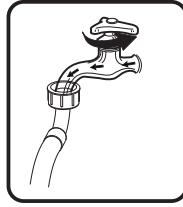

②

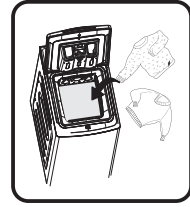

③

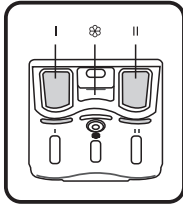

④

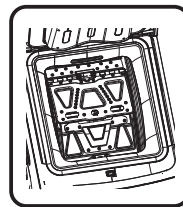

⑤

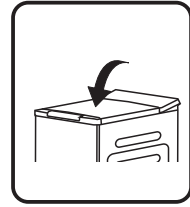

⑥

1. Enchufar
2. Abrir el grifo
3. Cargar
4. Añadir el detergente
5. Cierre la puerta del tambor
6. Cierre la puerta de la lavadora

**Nota:**

- Es necesario añadir detergente en el "compartimento I" después de seleccionar el prelavado para las lavadoras con esta función.
- Asegúrese de que las solapas del tambor estén correctamente bloqueadas.

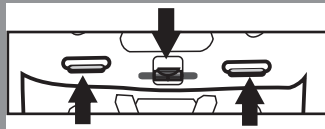

- Todos los ganchos metálicos deberán engancharse correctamente dentro de la solapa de la puerta trasera.

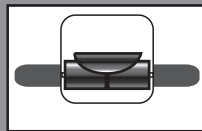

- Examine el rodillo antes de cada colada, deberá rodar suavemente.

- **Lavado**

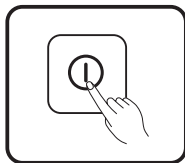

①

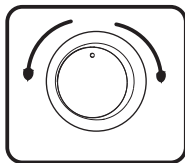

②

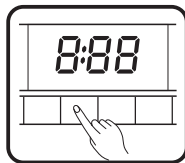

③

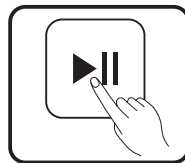

④

1. Encender
2. Seleccionar el programa
3. Seleccionar la función o mantener los ajustes predeterminados
4. Pulsar Inicio/Pausa para iniciar el programa

**Nota:**

- El paso 3 es opcional.

- **Después del lavado**

Todas las luces apagadas.

**Antes de cada lavado**

- La temperatura ambiente de la lavadora deberá ser de 5-40 °C. Si se usa a menos de 0 °C, la válvula de entrada y el sistema de desagüe pueden sufrir daños. Si la lavadora está colocada bajo condiciones de congelación, deberá llevarla a un lugar donde haya una temperatura ambiente normal para garantizar que la manguera de suministro de agua y el tubo de desagüe puedan descongelarse antes de su uso.
- Consulte las etiquetas de cuidados de sus prendas y las instrucciones de uso del detergente antes de lavarlas. Utilice detergente no espumante o menos espumante adecuado para lavar a máquina correctamente.

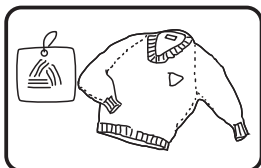

①

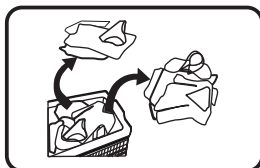

②

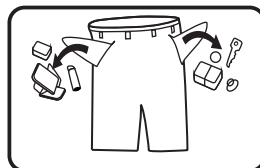

③

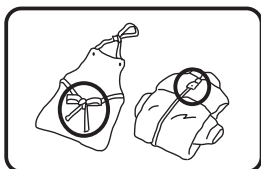

④

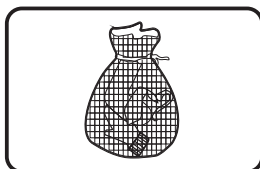

⑤

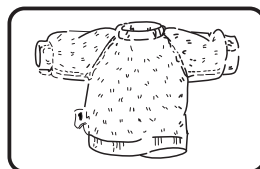

⑥

1. Consulte la etiqueta de cuidados
2. Separe las prendas por color y tipo de tela
3. Saque todos los objetos de los bolsillos
4. Ate los cordones y cinturones largos, cierre las cremalleras y los botones
5. Meta las prendas pequeñas en una bolsa de colada
6. Dé la vuelta a las prendas de pelo largo o que suelten pelusas



### ¡Advertencia!

- No lave prendas que hayan sido limpiadas, lavadas, impregnadas o remojadas en sustancias combustibles o explosivas como cera, aceite, pintura, gasolina, alcohol, queroseno y otros materiales inflamables.
- Lavar una sola prenda puede crear fácilmente una gran excentricidad y provocar una alarma debido al desequilibrio. Por lo tanto, se recomienda añadir una o dos prendas más para lavarlas juntas para que el centrifugado se pueda hacer sin problemas.
- No lave ni centrifugue esterillas, ropa o asientos impermeables.

### Dispensador de detergente

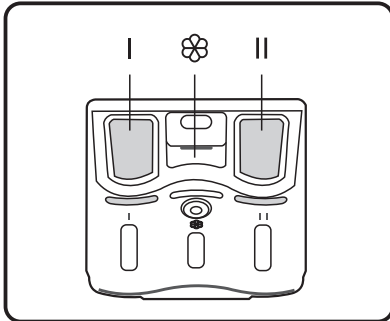

Saque el dispensador

- |   |                                 |
|---|---------------------------------|
| I   | Detergente del prelavado        |
| II  | Detergente del lavado principal |
|  | Suavizante                      |



### ¡Precaución!

- Solo es necesario añadir detergente en el "compartimento I" después de seleccionar el prelavado para las lavadoras con esta función.
- No supere la marca del nivel "MAX" cuando lo llene con detergente, aditivos o suavizante.

Programa	I	II	☼
15) Rápido 15'		●	○
45) Rápido 45'		●	○
ECO ECO 40-60		●	○
Vapor	○	●	○
Lana		●	○
Aclarar y centrifugar			○
Solo centrifugado			
Limpieza del tambor			
Ropa de bebé	○	●	○
20 °C		●	○
Ropa deportiva	○	●	○
Vaqueros	○	●	○
Mixto	○	●	○
Sintético	○	●	○
Algodón	○	●	○

● Significa «obligatorio» ○ Significa «opcional»

### Recomendación sobre detergentes

Detergente de lavado recomendado	Ciclos de lavado	Temperatura de lavado	Tipo de prenda y de tela
Detergente fuerte con agentes blanqueadores y blanqueadores ópticos	Algodón, Mixto	20/40/60	Prendas blancas de lino o algodón a prueba de ebullición
Detergente para color sin agente blanqueador ni blanqueadores ópticos	Algodón, Mixto	Fría/20/40	Prendas de color de algodón o lino
Detergente para color o suave sin blanqueadores ópticos	Sintético	Fría/20/40	Ropa de color de fibras de fácil cuidado o materiales sintéticos
Detergente de lavado suave	Sintético	20/40	Telas delicadas, seda, viscosa
Detergente de lana especial	Lana	20/40	Lana

**Nota:**

- El detergente o aditivo aglomerante o viscoso se puede diluir en un poco de agua antes de echarlo en el dispensador de detergente, para evitar que su entrada se bloquee y provoque un desbordamiento del agua.
- Elija el tipo de detergente adecuado para conseguir el máximo rendimiento de lavado y un mínimo consumo de agua y energía.
- Para lograr el mejor resultado de limpieza es importante una dosificación adecuada del detergente.
- Use una cantidad reducida de detergente si el tambor no está completamente lleno.
- Ajuste siempre la cantidad de detergente a la dureza del agua; si el agua del grifo es blanda, use menos detergente.
- Dosifique según lo sucia que esté la ropa, las prendas menos sucias requieren menos detergente.
- Los detergentes muy concentrados (detergentes compactos) requieren una dosificación especialmente precisa.

Los siguientes síntomas son un signo de sobredosis de detergente:

- formación de espuma espesa
- mal resultado del lavado y aclarado

Los siguientes síntomas son un signo de subdosis de detergente:

- las prendas se vuelven grises
- se acumulan depósitos de cal en el tambor, el elemento calefactor y/o la ropa



### Panel de control

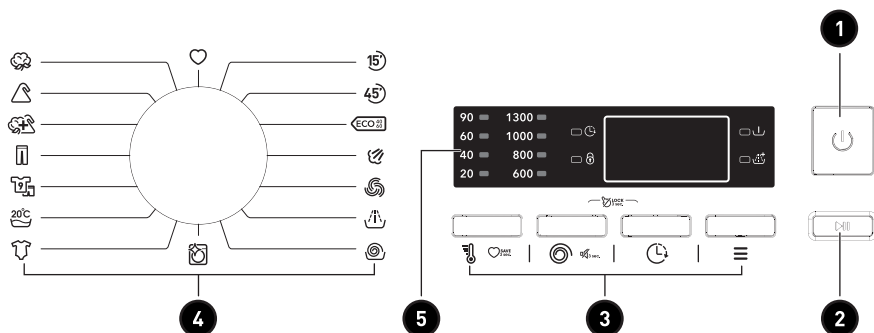

- 1 Alimentación** El producto está encendido/apagado.
- 2 Inicio/Pausa** Pulse el botón para iniciar o pausar el ciclo de lavado.
- 3 Opción** Esto le permite seleccionar una función adicional.
- 4 Programas** Disponibles según el tipo de prendas.
- 5 Pantalla** La pantalla muestra los ajustes, el tiempo restante estimado, las opciones y los mensajes del estado de la lavadora. La pantalla permanecerá encendida durante todo el ciclo.

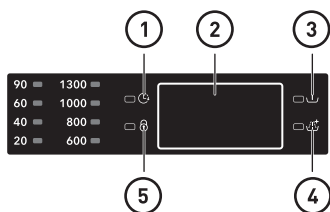















- 1** Programación diferida
- 2** Pantalla
 

Tiempo de lavado	Tiempo de retardo
125	2H
Fin	Error
End	E30

- ③ Prelavado
- ④ Aclarado extra
- ⑤ Bloqueo de puerta

### Programas

Modelo: WT 813 A W566C







Programa	Carga (kg)	Tiempo predeterminado
	8,0	
 Rápido 15'	2,0	0:15
 Rápido 45'	2,0	0:45
 ECO 40-60	8,0	3:38
 Vapor	4,0	1:47
 Lana	2,0	1:07
 Aclarar y centrifugar	8,0	0:20
 Solo centrifugado	8,0	0:12
 Limpieza del tambor	-	1:18
 Ropa de bebé	8,0	2:01
 20 °C	4,0	1:01
 Ropa deportiva	4,0	0:47
 Vaqueros	8,0	1:40
 Mixto	8,0	1:20
 Sintético	4,0	2:20
 Algodón	8,0	2:40



#### Nota:

- Los parámetros de esta tabla se indican únicamente como referencia para el usuario. Los ajustes reales pueden diferir de los de la tabla anterior.

## WT 813 A W566C

Ciclo	Capacidad nominal en kg	Ajuste de la temperatura	Duración del ciclo en horas y minutos	Consumo de energía en kWh/ciclo de funcionamiento	Consumo de agua en litros/ciclo de funcionamiento	Temperatura máxima °C <sup>(1)</sup>	Humedad residual en %/ velocidad de centrifugado en rpm <sup>(2)</sup>
 Rápido 15'	2,0	Fría	0:15	0,026	34	Fría	53%/800
	8,0	--	3:38	0,739	71	38	53,9%/1250
 ECO 40-60 <sup>(3)</sup>	4,0	--	2:48	0,456	47	32	53,9%/1250
	2,0	--	2:48	0,196	38	23	53,9%/1250
 20 °C	4,0	20	1:01	0,183	47	20	70%/800
 Mixto	8,0	40	1:20	0,754	44	40	70%/800
 Sintético	4,0	40	2:20	0,625	34	40	35%/800
 Algodón	8,0	60	2:45	1,394	71	60	53%/1300

- Los datos anteriores se indican solamente como referencia, y los datos pueden cambiar debido a las diferentes condiciones de uso reales.
- Las válvulas mencionadas para programas distintos al programa ECO 40-60 son únicamente indicativas.
- Cumple la norma EN 60456: 2016/prA2019 With (EU) 2019/2014, (EU) 2019/2023.  
La clase de eficiencia energética de la UE es: A  
Programa de pruebas energéticas: ECO 40-60. Otro por defecto.  
Media carga para la lavadora de 8,0 kg: 4,0 kg.  
Cuarto de carga para la lavadora de 8,0 kg: 2,0 kg.

<sup>1)</sup> La temperatura más alta alcanzada por la ropa en el ciclo de lavado durante al menos 5 minutos.

<sup>2)</sup> La humedad residual después del ciclo de lavado en el porcentaje del contenido de agua y la velocidad de centrifugado a la que llegó.

<sup>3)</sup> El programa ECO 40-60 puede lavar juntas en el mismo ciclo las prendas de algodón normalmente sucias que se pueden lavar a 40 °C o 60 °C. Este programa se utiliza para evaluar el cumplimiento del Reglamento (UE) 2019/2023.

Los programas más eficientes en términos de consumo de energía son generalmente los que funcionan a temperaturas más bajas y con una mayor duración.

La carga de la lavadora doméstica hasta la capacidad indicada para los respectivos programas contribuye al ahorro de energía y agua.

El ruido y la cantidad de humedad restante dependen de la velocidad de centrifugado: cuanto mayor sea la velocidad de centrifugado en la fase de centrifugado, mayor será el ruido y menor la humedad restante.

















### ¡Precaución!

- Si hay algún corte de alimentación mientras la lavadora está funcionando, una memoria especial guardará el programa seleccionado. La lavadora continuará el programa cuando se restablezca la fuente de alimentación.

### Programas

























Programas disponibles según el tipo de prendas.

Programas	
 Rápido 15'	Programa extracorto aprox., adecuado para lavados con poca suciedad como pequeñas cantidades de ropa.
 Rápido 45'	Lavar rápidamente poca ropa y no muy sucia.
 ECO 40-60	Puede lavar juntas en el mismo ciclo las prendas de algodón normalmente sucias que se pueden lavar a 40 °C o 60 °C.
 Vapor	El Lavado con vapor puede penetrar profundamente en la fibra, lo que elimina eficazmente bacterias y gérmenes, previniendo los olores y protegiendo la salud.
 Lana	Lana lavable a mano o a máquina o textiles de lana rica. Programa de lavado especialmente suave para evitar la contracción, pausas más largas del programa (las telas reposan en la solución de lavado).
 Aclarar y centrifugar	Aclara y luego centrifuga las prendas, y después desagua el agua.
 Solo centrifugado	Gira y drena el agua.
 Limpieza del tambor	Especialmente programado en esta lavadora para limpiar el tambor y el tubo. Aplica una esterilización a una alta temperatura de 90 °C para hacer que el lavado de ropa sea más ecológico. Cuando se utiliza este programa, no se puede añadir ropa ni otro tipo de lavado. Cuando se coloca la cantidad adecuada de agente blanqueador de cloro, mejora el efecto de limpieza del tambor. Puede utilizar este programa regularmente según sus necesidades.

 Ropa de bebé	Lave la ropa de bebé, puede hacer que el bebé lleve la ropa más limpia y mejorar el rendimiento del aclarado para proteger la piel del bebé.
 20 °C	Puede lavar la ropa de algodón ligeramente sucia, a una temperatura nominal de 20 °C.
 Ropa deportiva	Lavado de ropa deportiva.
 Vaqueros	Especialmente para vaqueros.
 Mixto	Carga mixta compuesta por tejidos de algodón y sintéticos.
 Sintético	Lave prendas sintéticas, por ejemplo: camisas, abrigos o mezclas. Cuando se laven los tejidos de punto, la cantidad de detergente se reducirá debido a su fabricación de hilo suelto y a la fácil formación de burbujas.
 Algodón	Telas muy resistentes o resistentes al calor de algodón o lino.

### Opción

Modelo: WT 813 A W566C

Ciclo	Temperatura predeterminada (°C)	Velocidad de centrifugado predeterminada en rpm	Funciones adicionales
Ciclos de lavado		1300	
 Rápido 15'	Fría	800	
 Rápido 45'	20	800	 , 
 ECO 40-60	--	--	
 Vapor	40	800	 ,  , 
 Lana	40	600	 , 
 Aclarar y centrifugar	--	800	 , 
 Solo centrifugado	--	800	
 Limpieza del tambor	90	--	
 Ropa de bebé	60	800	 ,  , 

20 °C	20	800	
Ropa deportiva	20	800	
Vaqueros	40	800	
Mixto	40	800	
Sintético	40	800	
Algodón	40	800	

**Nota:**

- Para conocer la velocidad máxima de centrifugado, el tiempo del programa y otra información del programa ECO 40-60, consulte el contenido en la página de la Ficha del producto.
- La tabla muestra las opciones de ajuste que ofrece cada ciclo. También indica si un ajuste no está disponible para un programa.

**Prelavado**

La función Prelavado permite realizar un lavado adicional antes del lavado principal, es adecuada para lavar el polvo de la superficie de la ropa; deberá introducir detergente en el Compartimento (I) cuando la seleccione.

**Aclarado extra**

Se realizará un aclarado adicional de las prendas una vez que la seleccione.

**Programación diferida**

Ajustar la función Retardo:

1. Seleccione un programa:
2. Pulse el botón de Retardo para elegir el tiempo de 0-24 h
3. Pulse [Inicio/Pausa] para iniciar la operación de retardo



Elija el programa



Ajuste el tiempo



Iniciar

Cancelar la función Retardo:

Pulse el botón [Retardo] hasta que aparezca en la pantalla 0H. Deberá presionarse antes de iniciar el programa. Si el programa ya ha comenzado, deberá desactivar el programa para restablecer uno nuevo.

**¡Precaución!**

- Si hay algún corte de alimentación mientras la lavadora está funcionando, una memoria especial guardará el programa seleccionado y cuando se restablezca la alimentación, el programa continuará.

**Temp.**

Pulse el botón para regular la temperatura (Fría, 20 °C, 40 °C, 60 °C, 90 °C)

**Centrifugado**

Pulse el botón para cambiar la velocidad.  
1300: 0-600-800-1000-1300

**Bloqueo para niños**

Para evitar la manipulación inadecuada por parte de niños.



Elija el programa



Pulse [Centrifugado] y [Retardo] durante 3 seg. hasta que suene el tono de aviso.

**¡Precaución!**

- Cuando esté activada la función "Bloqueo para niños", sonará el tono de aviso, cuando se presionen los botones.
- Pulse los dos botones durante 3 seg. también para desactivar la función.
- El "Bloqueo para niños" bloqueará todos los botones excepto el botón de Encendido.
- Corte el suministro de corriente, la protección para niños deberá liberarse.

**Silenciar el tono de aviso**

Elija el programa



Pulse el botón [Centrifugado] durante 3 segundos, el tono de aviso se silenciará.

Para activar la función del tono de aviso, presione el botón de nuevo durante 3 segundos. El ajuste se mantendrá hasta el siguiente reajuste.

**¡Precaución!**

- Después de silenciar la función del tono de aviso, los sonidos ya no se activarán.

**Mi ciclo**

Para recordar el programa de uso frecuente.

Después de elegir el programa y ajustar las opciones, pulse el botón [Temp.] durante 3 segundos antes de empezar a lavar. El ciclo de ajuste predeterminado es Algodón.

**Nota:**

Contador de uso

1. Desenchufe el aparato durante 10 segundos y vuelva a conectarlo.
2. Encienda y, al cabo de 10 seg., pulse "Temp." y "Función" en el panel de control de forma simultánea y continua durante unos 5 seg. hasta que la pantalla del aparato muestre los dígitos -- el valor puede indicar los tiempos de uso del aparato.
3. Repita el paso 1 de nuevo y podrá reanudar el funcionamiento normal.



## Limpieza y mantenimiento



### ¡Advertencia!

- Antes de iniciar el mantenimiento, desenchufe la máquina y cierre el grifo.

### Limpieza de la carcasa

El mantenimiento adecuado de la lavadora puede alargar su vida útil. La superficie se puede limpiar con detergentes neutros no abrasivos diluidos cuando sea necesario. Si hay algún desbordamiento de agua, use un paño mojado para limpiarla inmediatamente. No se permiten objetos afilados.

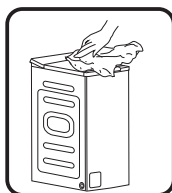

### Nota:

- Quedan prohibidos el ácido fórmico y sus disolventes diluidos o equivalentes, como alcohol, disolventes o productos químicos, etc.

### Limpieza del tambor

Los óxidos dejados en el interior del tambor por los artículos metálicos deberán eliminarse inmediatamente con detergentes sin cloro. Nunca uses lana de acero.



### Nota:

- No introduzca ropa en la lavadora durante la limpieza del tambor.

## Limpieza del filtro de entrada



### Nota:

- La disminución del flujo de agua es una señal de que el filtro debe limpiarse.

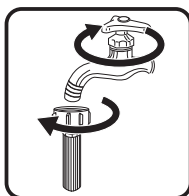

①

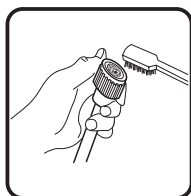

②

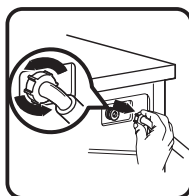

③

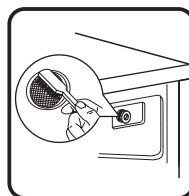

④

1. Cierre el grifo y retire la manguera de suministro de agua del mismo.
2. Limpie el filtro con un cepillo.
3. Desenrosque la manguera de suministro de agua de la parte trasera de la lavadora. Saque el filtro con unos alicates de punta.
4. Utilice un cepillo para limpiar el filtro.
5. Vuelva a colocar el filtro en la entrada de agua y vuelva a conectar la manguera de suministro de agua.
6. Limpie el filtro de entrada cada 3 meses para asegurarse de que el aparato funcione con normalidad.

## Limpie el dispensador de detergente

1. Presione hacia abajo la ubicación de la flecha en la tapa del suavizante dentro del cajón del dispensador.
2. Levante el clip y saque la tapa del suavizante y lave todas las ranuras con agua.
3. Vuelva a colocar la tapa del suavizante y empuje el cajón en su posición.

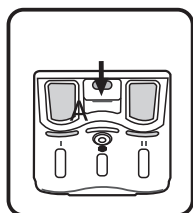

①



②

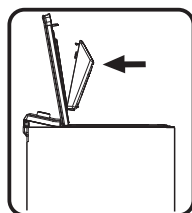

③

1. Saque el cajón del dispensador presionando la A.
2. Limpie el cajón del dispensador bajo el agua.
3. Introduzca el cajón del dispensador.

**Nota:**

- No utilice agentes abrasivos o cáusticos para limpiar las piezas de plástico.
- Limpie el dispensador de detergente cada 3 meses para asegurarse de que el aparato funcione con normalidad.

**Limpieza del filtro de la bomba de desagüe****¡Advertencia!**

- Asegúrese de que la lavadora ha terminado el ciclo de lavado y está vacía. Apáguela y desenchúfela antes de limpiar el filtro de la bomba de desagüe.
- Tenga cuidado con el agua caliente. Deje que se enfríe el agua. ¡Riesgo de quemaduras!
- Limpie el filtro periódicamente cada 3 meses para asegurarse de que el aparato funcione con normalidad.

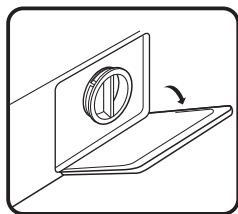

①

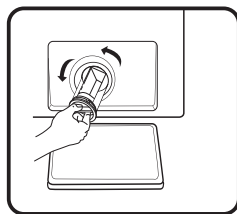

②

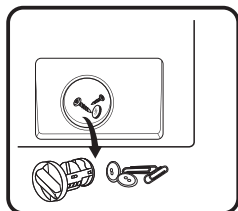

3

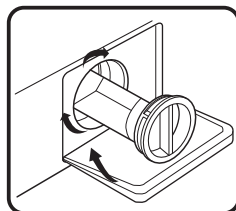

4

1. Abra la tapa inferior.
2. Abra el filtro girándolo en el sentido contrario a las agujas del reloj.
3. Elimine cualquier materia extraña.
4. Cierre la tapa inferior.

## Solución de problemas

El arranque del aparato no funciona o se detiene durante el funcionamiento. Primero intente encontrar una solución al problema. Si no, contacte con el centro de servicio técnico.

Descripción	Posible causa	Solución
La lavadora no arranca.	<ul style="list-style-type: none"> <li>• La puerta no está cerrada correctamente</li> </ul>	<ul style="list-style-type: none"> <li>• Reinicie después de cerrar la puerta. Compruebe si hay ropa atascada.</li> </ul>
La puerta no se puede abrir	<ul style="list-style-type: none"> <li>• El diseño de protección de seguridad de la lavadora está funcionando</li> </ul>	<ul style="list-style-type: none"> <li>• Desconecte la alimentación y reinicie el aparato</li> </ul>
Fugas de agua	<ul style="list-style-type: none"> <li>• La conexión entre el tubo de entrada o la manguera de salida no es estanca</li> </ul>	<ul style="list-style-type: none"> <li>• Examine y fije los tubos de agua</li> <li>• Limpie la manguera de salida</li> </ul>
Residuos de detergente en la caja	<ul style="list-style-type: none"> <li>• El detergente se humedece o se aglomera</li> </ul>	<ul style="list-style-type: none"> <li>• Limpie y seque el compartimento de detergente</li> </ul>

Descripción	Posible causa	Solución
El indicador o la pantalla no se encienden	<ul style="list-style-type: none"> <li>• Desconecte la alimentación</li> <li>• La placa de circuito impreso o el cableado tienen problemas de conexión</li> </ul>	<ul style="list-style-type: none"> <li>• Compruebe si la alimentación está desconectada y si el enchufe está conectado correctamente</li> </ul>
Ruido anormal	<ul style="list-style-type: none"> <li>• Los pernos de fijación siguen en su posición</li> <li>• El suelo no es firme o no está nivelado</li> </ul>	<ul style="list-style-type: none"> <li>• Compruebe si se han retirado los pernos de fijación</li> <li>• Compruebe que esté instalado sobre un suelo sólido y nivelado</li> </ul>

#### Modelos de pantalla LED:

E30	<ul style="list-style-type: none"> <li>• La puerta no está cerrada correctamente</li> </ul>	<ul style="list-style-type: none"> <li>• Reinicie después de cerrar la puerta</li> <li>• Compruebe si hay ropa atascada</li> </ul>
E10	<ul style="list-style-type: none"> <li>• Problema de inyección de agua durante el lavado</li> </ul>	<ul style="list-style-type: none"> <li>• Compruebe si la presión del agua es demasiado baja</li> <li>• Enderece la manguera de agua</li> <li>• Compruebe si el filtro de la válvula de entrada está obstruido</li> </ul>
E21	<ul style="list-style-type: none"> <li>• El desagüe del agua tarda demasiado tiempo</li> </ul>	<ul style="list-style-type: none"> <li>• Compruebe si el tubo de desagüe está obstruido</li> </ul>
E12	<ul style="list-style-type: none"> <li>• Desbordamiento del agua</li> </ul>	<ul style="list-style-type: none"> <li>• Reinicie la lavadora</li> </ul>
EXX	<ul style="list-style-type: none"> <li>• Otros</li> </ul>	<ul style="list-style-type: none"> <li>• Inténtelo de nuevo primero, llame al teléfono de asistencia si persisten los problemas</li> </ul>



#### Nota:

- Tras la comprobación, active el aparato. Si el problema persiste o la pantalla vuelve a mostrar otros códigos de alarma, póngase en contacto con el servicio técnico.

**¡Advertencia!**

Riesgo de descarga eléctrica

- Nunca intente reparar un aparato que esté defectuoso o presuntamente defectuoso. Podría poner en peligro su propia vida o la de futuros usuarios. Solo los especialistas autorizados pueden realizar estos trabajos de reparación.
- ¡Una reparación incorrecta anulará la garantía y los daños posteriores no podrán ser reconocidos!

**Transporte****PASOS IMPORTANTES AL MOVER EL APARATO**

- Desenchufe el aparato y cierre el grifo de entrada de agua.
- Compruebe si la puerta y el dispensador de detergente están cerrados correctamente.
- Retire la manguera de entrada de agua y la manguera de salida de las instalaciones domésticas.
- Desagüe completamente el agua del aparato (consulte el apartado «Mantenimiento y limpieza del filtro de la bomba de desagüe»).
- Importante: Vuelva a instalar los 4 pernos de transporte en la parte trasera del aparato.
- Este aparato es pesado. Transpórtelo con cuidado. Nunca sostenga ninguna parte sobresaliente de la lavadora cuando la levante. La puerta de la lavadora no se puede utilizar como asa.

## Ficha del producto

**Nombre del proveedor o marca comercial<sup>(a),(c)</sup>:**

**Dirección del proveedor<sup>(a),(c)</sup>:**

**Identificador del modelo<sup>(a)</sup>: WT 813 A W566C**

**Parámetros generales del producto:**

Parámetro	Valor		Parámetro	Valor	
Capacidad nominal <sup>(b)</sup> (kg)	8,0		Dimensiones en cm <sup>(a),(c)</sup>	Altura	88
				Anchura	40
				Profundidad	61
Índice de eficiencia energética <sup>(b)</sup> (EEI <sub>w</sub> )	51,9		Clase de eficiencia energética <sup>(b)</sup>	A <sup>(d)</sup>	
Índice de eficiencia de lavado <sup>(b)</sup>	1,031		Eficacia del aclarado (g/kg) <sup>(b)</sup>	5,0	
Consumo de energía en kWh por ciclo, basado en el programa eco 40-60. El consumo de energía real dependerá de cómo se utilice el aparato.	0,472		Consumo de agua en litros por ciclo, basado en el programa eco 40-60. El consumo de agua real dependerá de cómo se utilice el aparato y de la dureza del agua.	48	
Temperatura máxima en el interior del textil tratado <sup>(b)</sup> (°C)	Capacidad nominal	38	Contenido ponderado de humedad restante <sup>(b)</sup> (%)	53,9	
	Media carga	32			
	Cuarto de carga	23			
Velocidad de centrifugado <sup>(b)</sup> (rpm)	Capacidad nominal	1250	Clase de eficiencia de secado por centrifugado <sup>(b)</sup>	B <sup>(d)</sup>	
	Media carga	1250			
	Cuarto de carga	1250			

## Ficha del producto

Duración del programa <sup>(b)</sup> (h:min)	Capacidad nominal	3:38	Tipo	independiente
	Media carga	2:48		
	Cuarto de carga	2:48		
Emisiones de ruido acústico aéreo en la fase de centrifugado <sup>(a)</sup> (dB(A) re 1 pW)	78	Clase de emisión de ruido acústico aéreo <sup>(b)</sup> (fase de centrifugado)	C <sup>(d)</sup>	
Modo apagado (W) (si procede)	0,50	Modo de espera (W) (si procede)	N/A	
Retardo en el inicio (W) (si procede)	4,00	Modo de espera en red (W) (si procede)	N/A	
<b>Duración mínima de la garantía ofrecida por el proveedor<sup>(a),(c)</sup>:</b>				
<b>Este producto ha sido diseñado para liberar iones de plata durante el ciclo de lavado</b>			NO	

### Información adicional:

Enlace web al sitio web del proveedor, donde se encuentra la información del apartado 9 del anexo II del Reglamento de la Comisión (UE) 2019/2023 (1):

<sup>(a)</sup> este punto no se considerará relevante a efectos del artículo 2, apartado 6, del Reglamento (UE) 2017/1369.

<sup>(b)</sup> para el programa eco 40-60.

<sup>(c)</sup> las modificaciones de este punto no se considerarán relevantes a efectos del artículo 4, apartado 4, del Reglamento (UE) 2017/1369.

<sup>(d)</sup> si la base de datos de productos genera automáticamente el contenido definitivo de esta celda, el proveedor no introducirá estos datos.

- El consumo de energía real dependerá de cómo se utilice el aparato.
- El consumo de agua real dependerá de cómo se utilice el aparato y de la dureza del agua.
- Entrega de las piezas de repuesto en un plazo de 15 días laborables tras haber recibido el pedido.

Ficha técnica del producto relativa a (UE) 2019/2014.

La ficha técnica del producto para su aparato está disponible en Internet.

Vaya a <https://eprel.ec.europa.eu> e introduzca el identificador del modelo de su aparato para descargar la ficha técnica.

Puede encontrar el identificador del modelo de su aparato en el apartado de especificaciones técnicas.









## WARRANTY CONDITIONS

EN

This product is guaranteed against faults caused by defects in manufacturing or the materials used for a period of two years, starting from the date of purchase.\* This warranty does not cover defects or damage caused by failure to install the device correctly, incorrect use of the product, or excessive wear and tear.

\*proof of purchase required.

## CONDITION DE GARANTIE

FR

Ce produit est garanti pour une période de 2 ans à partir de la date d'achat\*, contre toute défaillance résultant d'un vice de fabrication ou de matériau. Cette garantie ne couvre pas les vices ou les dommages résultant d'une mauvaise installation, d'une utilisation incorrecte ou de l'usure anormale du produit.

\*sur présentation du ticket de caisse.

## GARANTIEVOORWAARDEN

NL

Dit product wordt gegarandeerd voor een periode van 2 jaar vanaf de aankoopdatum\*, voor elke storing die het gevolg is van een fabricagefout of het materiaal. Gebreken of schade door slechte installatie, onjuist gebruik of abnormale slijtage van het product worden niet gedekt door deze garantie.

\*op vertoon van kassabon.

## CONDICIONES DE GARANTÍA

ES

El certificado de garantía de este producto tiene una duración de 2 años a partir de la fecha de compra\* que se limita a los defectos de fabricación y averías del material. Se excluyen de la garantía deficiencias o daños originados por una mala instalación, errores en la manipulación o por un uso inadecuado.

\*previa presentación del comprobante de compra.

ELECTRO DEPOT

1 route de Vendeville

59155 FACHES-THUMESNIL - FRANCE

