

CUISINE **SABA**

FL914L21W
FL1015L21W
FL1214L21W

GB



CONFORAMA France SA
80 Boulevard du Mandinet
LOGNES
77432 Marne la Vallée Cedex 2
FRANCE

Thank you for choosing SABA quality. This product has been developed by our team of professional and according to European regulations. In order to get the most out of your new appliance, we recommend that you read this instruction manual carefully and keep it for future reference.

TABLE OF CONTENTS

SAFETY INSTRUCTIONS	50
INSTALLATION	57
OPERATIONS	63
MAINTENANCES	81
DISPOSAL OF OLD ELECTRICAL APPLIANCES	95

SAFETY INSTRUCTIONS

- Safety Instructions

For your safety, the information in this manual must be followed to minimize the risk of fire or explosion, electric shock, or to prevent property damage, personal injury or loss of life.

Explanation of the symbols:

 **Warning!**

This combination of symbol and signal word indicates a potentially dangerous situation which may result in death or serious injuries unless it's avoided.

GB

 **Caution!**

This combination of symbol and signal word indicates a potentially dangerous situation which may result in slight or minor injuries or damage to property and the environment.

 **Note!**

This combination of symbol and signal word indicates a potentially dangerous situation which may result in slight or minor injuries.

- This appliance is intended to be used in household and similar applications such as:
 - staff kitchen areas in shops, offices and other working environments;
 - farm houses;
 - by clients in hotels, motels and other residential type environments;

- bed and breakfast type environments.
- Areas for communal use in blocks of flats or in launderettes.
- This appliance is designed to wash 9.0 /10.0 /12.0 kg of dry laundry

Warning!

The electric shock!

- If the supply cord is damaged, it must be replaced by the manufacturer, its service agent or similarly qualified persons in order to avoid a hazard.
- The new hose-sets supplied with the appliance are to be used and that old hose-sets should not be reused.
- Before any maintenance the device, unplug the appliance from the mains.
- Always unplug the machine and turn off the water supply after use. The max. inlet water pressure, in 1 mPa. The min. inlet water pressure, 0.05 mPa.
- To ensure your safety, power plug must be inserted into an earthed three-pole socket. Check carefully and make sure that your socket is properly and reliably earthed.
- Make sure that the water and electrical devices must be connected by a qualified technician in accordance with the manufacturer's instructions and local safety regulations.
- Pull out its plug from the power socket before cleaning or maintenance.

- Do not use any socket with rated current less than that of appliance. Never pull out power plug with wet hand.
- Please remember to disconnect water and power supply immediately after the clothes are washed.

Risk to children!

- EN countries: the appliance can be used by children aged from 8 years and above and persons with reduced physical, sensory or mental capabilities or lack of experience and knowledge if they have been given supervision or instruction concerning use of the appliance in a safe way and understand the hazards involved. Children shall not play with the appliance. Cleaning and user maintenance shall not be made by children without supervision.
- Children of less than 3 years should be supervised to ensure that they do not play with appliance.
- Animals and children may climb into the machine. Check the machine before every operation.
- Kids should be supervised that they do not play with the appliance.

SAFETY INSTRUCTIONS

- Glass door may be very hot during the operation. Keep kids and pets far away from the machine during the operation very wet rooms as well as in the rooms with explosive or caustic gas.
- Remove all packages and transport bolts before using the appliance. Otherwise, serious damage may result.

Risk of explosion!

- Do not wash or dry articles that have been cleaned in, washed in, soaked in, or dabbed with combustible or explosive substances (such as wax, oil, paint, gasoline, degreasers, dry-cleaning solvents, kerosene, etc.) This may result in fire or explosion.
- The washer dryer is not to be used if industrial chemicals have been used for cleaning.
- The exhaust air must not be discharged into a flue which is for exhausting fumes from appliances burning gas or other fuels.
- Beforehand thoroughly rinse items of washing by hand.

⚠ Caution!

Installing the product!

- This appliance is for indoor use only.
- It isn't intended to be built-in using.
- The openings must not be obstructed by a carpet.
- The appliance shall not be installed in bathroom or very wet rooms as well as in the rooms with explosive or caustic gases.
- The appliance with single inlet valve only can be connected to the cold water supply. The appliance with double inlet valves should be correctly connected to the hot water and cold water supply.
- Plug must be accessible after installation.
- The appliance must not be installed behind a lockable door, a sliding door or a door with a hinge on the opposite side to that of the washer dryer.

- The appliance shall not be installed at a humid place.
- Remove all packages and transport bolts before using the appliance. Otherwise, serious damage may result.

Risk of damaging appliance!

- The product is only for home use and is only designed for the textiles suitable for machine washing and drying.
- Do not climb up and sit on top cover of the machine.
- Do not lean against machine door.
- Cautions during Handling Machine:
 1. Transport bolts shall be reinstalled to the machine by a specialized person.
 2. The accumulated water shall be drained out of the machine.
 3. Handle the machine carefully. Never hold each protruded part on the machine while lifting. Machine door cannot be used as the handle during the conveyance.
 4. This appliance is heavy. Transport with care.
 5. That the hands shall not be inserted into running water extracting tub.
- Please do not close the door with excessive forces. If it is found difficult to close the door, please check if the clothes are put in or distributed well.
- It is forbidden to wash carpets.

Operating the appliance!

- Before using the wash machine, the product shall be calibrated.

- Before washing the clothes at first time, the product shall be operated in one round of the whole procedures without the clothes inside.
- Flammable and explosive or toxic solvents are forbidden. Gasoline and alcohol etc. shall not be used as detergents. Please only select the detergents suitable for machine washing, especially for drum.
- Make sure that all pockets are emptied. Sharp and rigid items such as coin, brooch, nail, screw or stone etc. may cause serious damages to this machine.
- Please check whether the water inside the drum has been drained before opening its door. Please do not open the door if there is any water visible.
- Be careful of burning when the product drains hot washing water.
- After the program is completed, please wait for two minutes to open the door.
- Never refill the water by hand during washing.
- If it is unavoidable that fabrics that contain vegetable or cooking oil or have been contaminated by hair care products, if placed in a tumble dryer they should first be washed in hot water with extra detergent, this will reduce, but not eliminate, the hazard.
- Adequate ventilation has to be provided to avoid the back flow of gases into the room from appliances burning other fuels, including open fires.

- Do not dry unwashed items in the appliance.
- Items that have been soiled with substances such as cooking oil, acetone, alcohol, petrol, kerosene, spot removers, turpentine, waxes and wax removers should be washed in hot with an extra amount of detergent before being dried in the appliance.
- Items such as foam rubber (latex foam), shower caps, water-proof textiles, rubber backed articles and clothes or pillows fitted with foam rubber pads should not be dried in the machine.
- Fabric softeners, or similar products, should be used as specified by the fabric softener instructions.
- The machine whose lid can be opened during water extraction, that it takes 15s or more for complete stop of water extracting chamber tub.
- The final part of a washer dryer cycle occurs without heat (cool down cycle) to ensure that the items are left at a temperature that ensures that the items will not be damaged.
- Remove all objects from pockets such as lighters and matches before use the appliance.
- **WARNING:** Never stop a washer dryer before the end of the drying cycle unless all items are quickly removed and spread out so that the heat is dissipated.

Installation

• Product Description

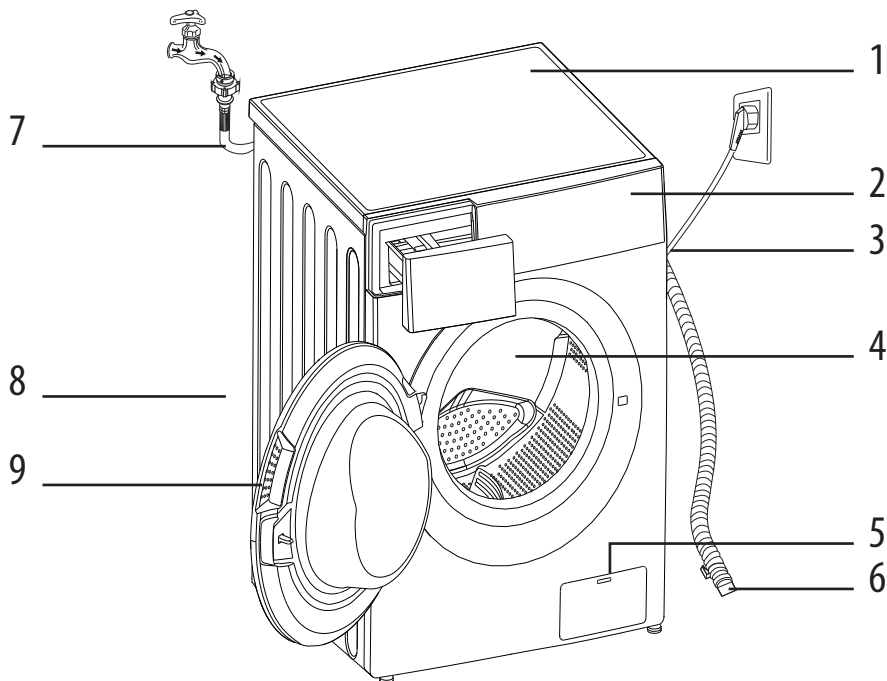

- | | |
|----------------------|------------------------|
| 1. Top cover | 6. Drain hose |
| 2. Control panel | 7. Water supply hose |
| 3. Power supply cord | 8. Detergent dispenser |
| 4. Drum | 9. Door |
| 5. Service filter | |

Note!

- The product line chart is for reference only, please refer to real product as standard.

Accessories



Transport hole
plug

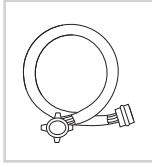

Supply hose
cold water

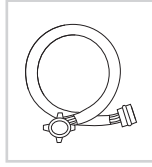

Supply hose hot
water (optional)

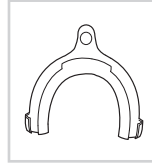

Drain hose
support
(optional)

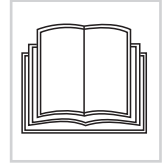

Owner's manual

Installation area

Warning!

GB

- Stability is important to prevent the product from wandering!
- Make sure that the product should not stand on the power cord.

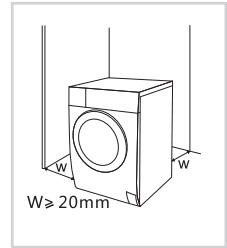

Before installing the machine, the location characterized as follows shall be selected:

1. Rigid, dry, and level surface
2. Avoid direct sunlight
3. Sufficient ventilation
4. Room temperature is above 0°C
5. Keep far away from the heat resources such as coal or gas.

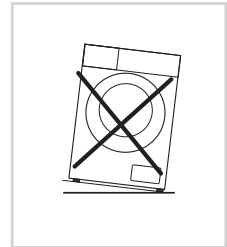

Unpacking the washing machine

Warning!

- Packaging material (e.g. Films, Styrofoam) can be dangerous for children.
- There is a risk of suffocation! Keep all packaging well away from children.

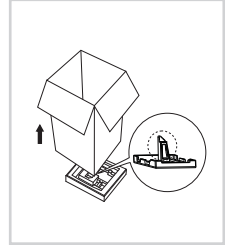

1. Remove the cardboard box and Styrofoam packing.
2. Lift the washing machine and remove the base packing. Make sure the small triangle foam is removed with the bottom one together. If not, lay the unit down with side surface, then remove the small foam from the unit bottom manually.
3. Remove the tape securing the power supply cord and drain hose.
4. Remove the inlet hose from the drum.

GB

Remove transport bolts

Warning!

- You must remove the transport bolts from the backside before using the product.
- You'll need the transport bolts again if you move the product, so make sure you keep them in a safe place.

Please take the following steps to remove the bolts:

1. Loosen 4 bolts with spanner and then remove them.
2. Stop the holes with transport hole plugs.
3. Keep the transport bolts properly for future use.

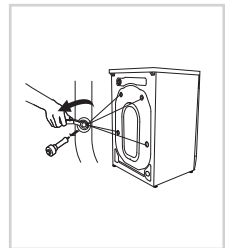

Levelling the washing machine

⚠ Warning!

- The lock nuts on all four feet must be screwed tightly against the housing.
1. Check if the legs are closely attached to the cabinet. If not, please turn them to their original positions tighten the nuts.
 2. Loosen the lock nut turn the feet until it closely contacts with the floor.
 3. Adjust the legs and lock them with a spanner, make sure the machine is steady.

GB

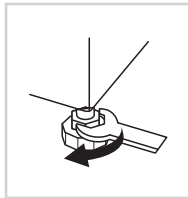
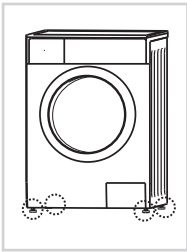

Raise

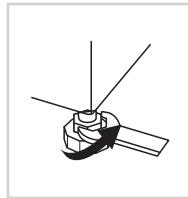

Lower

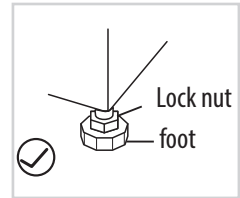

foot

Connect Water Supply Hose

⚠ Warning!

- To prevent leakage or water damage, follow the instructions in this chapter!
- Do not kink, crush, modify or sever water inlet hose.
- For the model equips hot valve, connect it to hot water tap with hot water supply hose. Energy consumption will decrease automatically for some program.

Connect the inlet pipe as indicated, there are two ways to connect the inlet pipe.

1. Connection between ordinary tap and inlet hose.

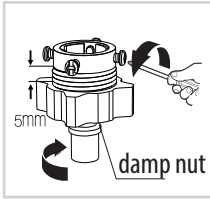

Loosen clamp nut and four bolts

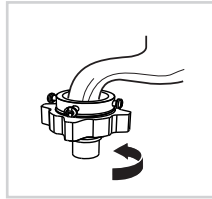

Tighten clamp nut

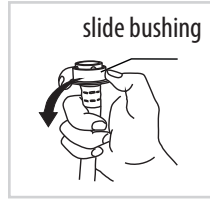

Press slide bushing, insert inlet hose into connecting base

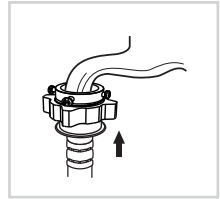

Connection finished

2. Connection between screw tap and inlet hose.

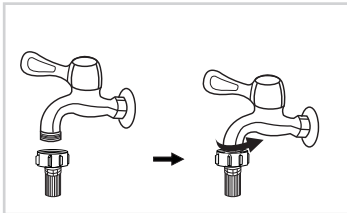

Tap with threads and inlet hose



Special tap for washing machine

GB

Connect the other end of inlet pipe to the inlet valve at the backside of product and fasten the pipe tightly clockwise.

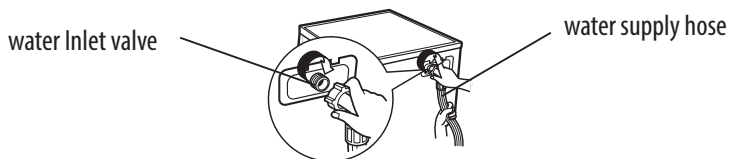

Drain Hose

⚠ Warning!

- Do not kink or protract the drain hose.
- Position drain hose properly, otherwise damage might result of water leakage.

GB

There are two ways to place the end of drain hose:

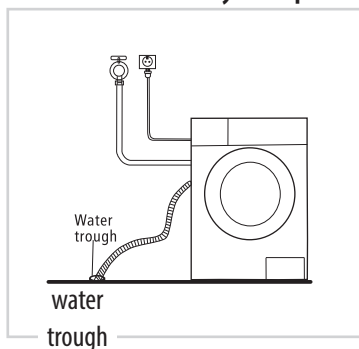

1. Put it into the water trough.

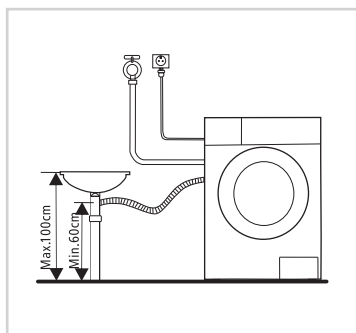

2. Connect it to the branch drainpipe of the trough.

📌 Note!

- If the machine has drain hose support, please install it like the following .

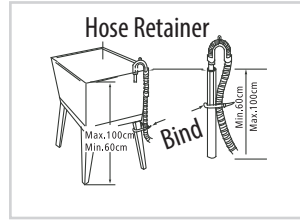
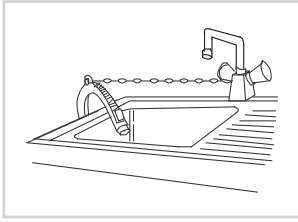

⚠ Warning!

- When installing drain hose, fix it properly with a rope.
- If drain hose is too long, do not force it into washing machine as it will cause abnormal noises.

GB

Operations

Quick Start

⚠ Caution!

- Before washing, please make sure it's installed properly.
- Before washing at first time, the washing machine shall be operated in one round of the whole procedures without clothes in as follows.

📌 Calibration

It is recommended to calibrate the wash machine so that can serve you better.

1. Empty the wash machine;
2. Plug in;

3. Power on the wash machine and press «Delay» and «Spin» at the same time within 10 seconds then display « t19 »
4. Press ►|| to start the wash machine and wait till display «****»

1. Before Washing

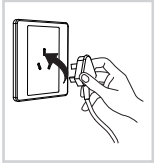

Plug in

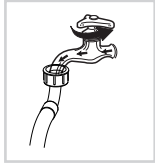

Open tap

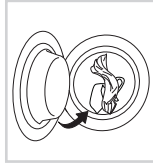

Load

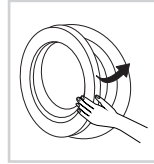

Close door

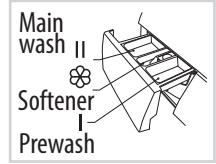

Add detergent

GB

Note!

- Detergent need to be added in «case I» after selecting pre-washing for machines with this function.

2. Before Washing

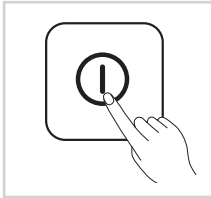

Power On

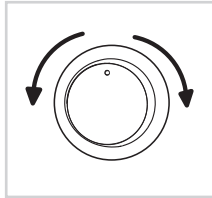

Select Programme

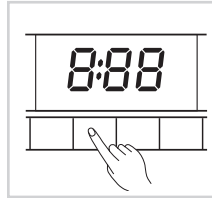

Select function or
default

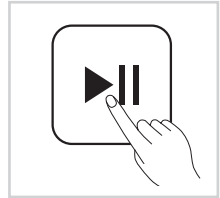

Start up

Note!

1. If default is selected, step 3 can be skipped.
2. The function button line chart is for reference only, please refer to real product as standard.

3. After Washing

Buzzer beep or «End» on display.

Before Each Washing

- The working condition of the washer should be (0-40)°C. If it is used under 0°C, the inlet valve and draining system may be damaged. If the machine is placed under condition of 0°C or less, then it should be transferred to normal ambient temperature to ensure the water supply hose and drain hose are not frozen before use.
- Please check the labels and the explanation of using detergent before wash. Use non-foaming or less-foaming detergent suitable for machine washing properly.

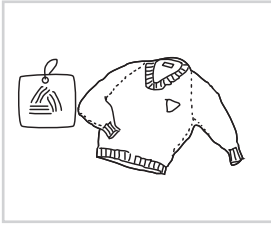

Check the label

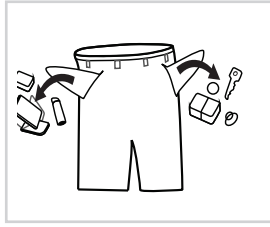

Take out the items out of the pockets

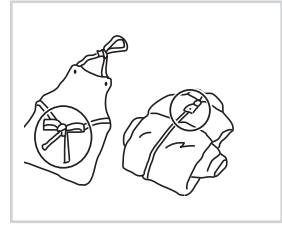

Knot the long strips.zip or button

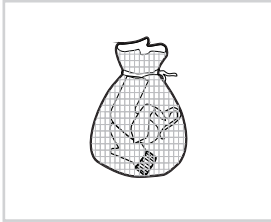

Put small clothes into the pillowslip

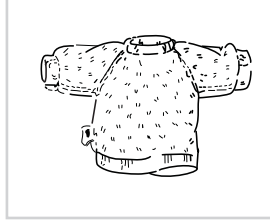

Turn easy-pilling and long-pile fabric inside out

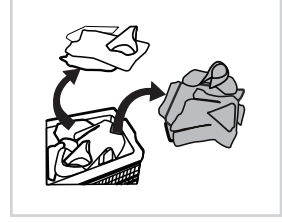

Separate clothes with different textures

GB

Warning!

- When washing a single piece of clothes, it may easily cause great eccentricity and give alarm due to great unbalance. Therefore it is suggested to add one or two more clothes to be washed together so that draining can be done smoothly.
- Don't washing the clothes touching with kerosene, gasoline, alcohol and other flammable materials.

Detergent Dispenser

- I Pre-Wash detergent
- II Main Wash detergent
- ☼ Softener

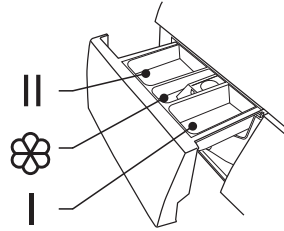

Pull out the dispenser

⚠ Caution!

- Detergent only need to be added in «case I» after selecting pre-washing for machines with this function.

Programme	I	II	☼	Programme	I	II	☼
Coton	○	●	○	Intensive		●	○
Synthetic	○	●	○	ECO 40-60		●	○
Sterilization	●	●	○	Delicate		●	○
Jeans	○	●	○	Wool		●	○
Mix	○	●	○	Sportwear	○	●	○
20°C		●	○	Rapid 45'	○	●	○
Rinse & Spin			○	Quick 15'		●	○
Spin Only							
● Means must ○ Means optional							

Note!

- As for the agglomerated or ropy detergent or additive, before they are poured into the detergent box, it is suggested to use some water for dilution to prevent the inlet of detergent box from being blocked and overflowing while filling water.
- Please choose suitable type of detergent for the various washing temperature to get the best washing performance with less water and energy consumption.

Control Panel

GB

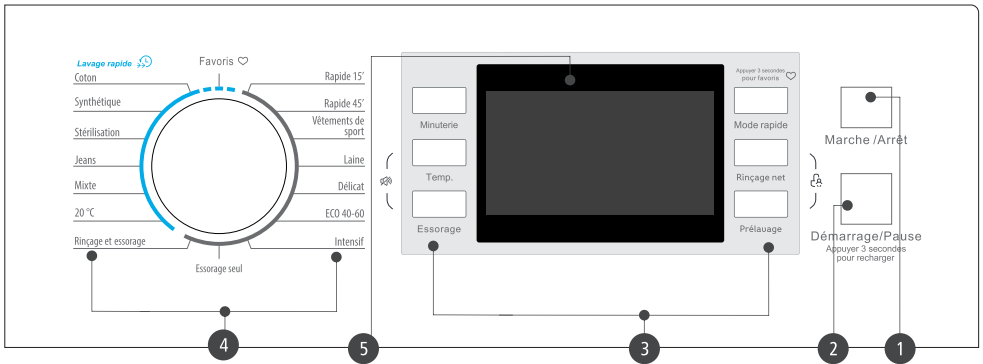

Note!

- The chart is for reference only, Please refer to real product as standard.

① On/off

Product is switched On/Off.

② Start/Pause

Press the button to start or pause the washing cycle.

③ Option

This allows you to select an additional function and will light when selected.

④ Programmes

Available according to the laundry type.

⑤ Display

The display shows the settings, estimated time remaining, options, and status messages for your washer. The display will remain on through the cycle.

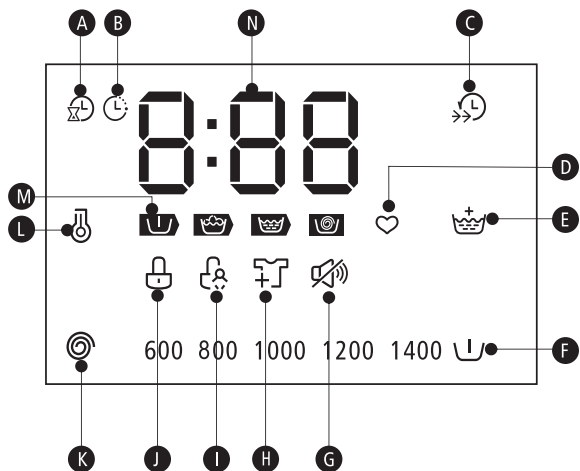

GB

- | | | | |
|---|---|---|-------------|
| A | Remain | G | Mute Buzzer |
| B | Delay | H | Reload |
| C | Speed Wash | I | Child Lock |
| D | My Cycle | J | Door Lock |
| E | Extra Rinse | K | Spin Speed |
| F | Pre Wash | L | Temp. |
| M | Rate Of Progress (Pre Wash- Wash -Rinse-Spin) | | |
| N | Wash Time | | Delay Time |
| | 125 | | 2h |
| | Error | | End |
| | E20 | | End |

Option



Delay

Set the Delay function:

1. Select a programme;
2. Press the Delay button to choose the time (the delaying time is 0-24 H.);
3. Press [Start/Pause] to commence the delay operation



Choose the Programme



Setting time



Start

GB

Cancel the Delay function:

Press the [Delay] button until the display be 0H. It should be pressed before starting the programme. If the programme already started, should switch off programme to reset a new one.

⚠ Caution!

- If there is any break in the power supply while the machine is operating, a special memory stores the selected programme and when the power is restarted, the program will continue.

Pre Wash

Pre Wash

The Prewash function can get an extra wash before main wash. It is suitable for washing the dust rises to surface of the clothes. You need to put detergent into the Case (I) when select it.

Extra Rinse

Extra Rinse

The laundry will undergo extra rinse once after you select it.

Speed Wash

Speed Wash

The function can decrease the washing time.

GB



My Cycle

To memory the frequently used programme. After choosing the programme and setting the options, press [Speed Wash ] 3 sec. before start to wash. The default setting course is Cotton.



Reload

This operation can be executed during the washing progress. When the drum is still rolling and there is large amount of water with high temperature in the drum. The state is unsafe and the door cannot be opened forcefully. To press [Start/Pause] for 3 sec. to reload, and start the clothes adding in the midway function. Please follow the steps as bellow:

1. Wait until the drum stops rotation.
2. The door lock is unlocked.
3. Close the door when the clothes are reloaded and press the [Start/Pause] button.

GB



Press [Start/Pause]3sec.



Reload the clothes



Start

⚠ Caution!

- Don't use the Reload function when the water level over the edge of the inner tub or the temperature is higher.

Other Functions

Temp.	Temp. Press the button to regulate the temperature (Cold,20°C,30°C, 40°C,60°C,90°C)
Spin	Spin Press the button to change the speed. 1400:0-600-800-1000-1200-1400 1500:0-600-800-1000-1200-1500

GB

Programme	Default Speed(rpm)	
	1400	1500
Cotton	1400	1500
Synthetic	1200	1200
Sterilization	800	800
Jeans	800	800
Mix	800	800
20°C	1000	1000
Rinse & Spin	1000	1000
Spin Only	1000	1000
Intensive	800	800
ECO 40-60	1400	1500
Delicate	600	600
Wool	600	600

Programme	Default Speed(rpm)	
	Sportwear	800
Rapid 45'	800	800
Quick 15'	800	800



Child Lock

To avoid mis operation by children.

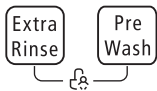

Press [Extra Rinse] and [Pre Wash]
3 sec. till buzzer beep.

GB

⚠ Caution!

When child lock is activated and program starts, child lock indicator will switch on, and the CL and remaining time on the display are alternately displayed in 0.5s. Press the other buttons will make child lock indicator flash for 3s. when program finish, CL and END alternate for 10s in 0.5s, then the child lock lights flash for 3s

- Only press and hold the two buttons can release child lock, even power off, switch off and program end
- The «Child Lock» will lock all buttons except Power button and Child Lock button
- Please release child lock before selecting program and starting washing



Mute the buzzer



Choose the
Programme

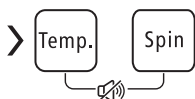

Press the [Temp.] and [Spin] for 3sec., the
buzzer is mute.

To act the buzzer function, press the button again for 3 seconds.
The setting will be kept until the next reset.

GB

⚠ **Caution!**

- After Muting the buzzer function, the sounds will not be activated any more.

Programmes

Programmes are available according to the laundry type.

Programmes	
Cotton	Hard-wearing textiles, heat-resistant textiles made of cotton or linen.
Synthetic	Wash synthetic articles, for example: shirts, coats, blending. While washing the knitting textiles, detergent quantity shall be reduced due to its loose string construction and easily forming bubbles.
Sterilization	Keep the washing temperature above 60 degrees for more than 30 minutes, effectively remove harmful bacteria.
Jeans	Specially for jeans.
Mix	Mixed load consisting of textiles made of cotton and synthetics.
20°C	20°C default, can choose cold water.
Rinse & Spin	Extra rinse with spin.
Spin Only	Extra spin with selectable spin speed.
Intensive	To increase the washing effects, washing time is increased.

ECO 40-60	This program is specially designed for washing duvet coats. Default 40°C, not selectable, suitable for laundry washing at about 40°C-60°C.
Delicate	For delicate, washable textiles, e.g. made of silk, satin, synthetic fibres or blended fabrics.
Wool	Hand or machine-washable wool or rich wool textiles. Especially gentle wash programme to prevent shrinkage, longer programme pauses (textiles rest in wash liquor).
Sport Wear	Washing the activewear.
Rapid 45'	This programme is suitable for washing not very dirty clothes, save more energy and washing.
Quick 15'	Extra short programme approx., suitable for lightly soiled washing as a small amount of laundry.

Washing Programmes Table

Programme	Load(kg)			Temp.CC)	Default Time
	9.0	10.0	12.0		
				Default	9.0/10.0/12.0
Cotton	9.0	10.0	12.0	40	2:59
Synthetic	4.5	5.0	6.0	40	2:45
Sterilization	9.0	10.0	12.0	-	2:30

Jeans		9.0	10.0	12.0	60	1:45
Mix		9.0	10.0	12.0	40	0:58
20°C		9.0	10.0	12.0	20	1:01
Rinse & Spin		9.0	10.0	12.0	-	0:20
Spin Only		9.0	10.0	12.0	-	0:12
Intensive		9.0	10.0	12.0	40	3:48
ECO 40-60		9.0	10.0	12.0	-	3:13/ 3:32/ 3:41/ 3:53/ 3:56
Delicate		9.0	10.0	12.0	30	0:50
Wool		2.0	2.0	2.0	40	1:07
Sport Wear		9.0	10.0	12.0	20	0:45
Rapid 45'		2.0	2.5	2.5	40	0:45
Quick 15'		2.0	2.5	2.5	Cold	0:15

- Concerning to Regulation (EU) 2019/2023,
The EU energy efficiency class is: B Energy test program: ECO 40-60. Other as the default. Half load for 9.0/10.0/12.0Kg machine:4.5/5.0/6.0Kg. Quarter load for 9.0/10.0/12.0Kg machine:2.5/2.5/3.0Kg.

Note!

- The parameters in this table are only for user's reference. The actual parameters maybe different with the parameters in above mentioned table.

Maintenances

Cleaning And Care

⚠ Warning!

- Before your maintenance starts, please unplug the machine and close the tap.

Cleaning The Cabinet

Proper maintenance on the washing machine can extend its working life. The surface can be cleaned with diluted non-abrasive neutral detergents when necessary. If there is any water overflow, use the wet cloth to wipe it off immediately. No sharp items are allowed.

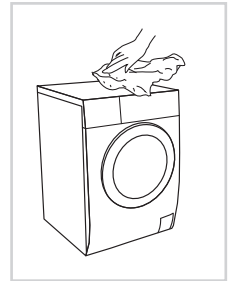

GB

📌 Note!

- Formic acid and its diluted solvents or equivalent are forbidden, such as alcohol, solvents or chemical products, etc.

Cleaning The Drum

The rusts left inside the drum by the metal articles shall be removed immediately with chlorine-free detergents. Never use steel wool.

Note!

Don't put laundry in the washing machine during the drum cleaning.

Cleaning The Door Seal And Glass

Wipe the glass and seal after each wash to remove lint and stains. If lint builds up it can cause leaks.

Remove any coins, buttons and other objects from the seal after each wash.

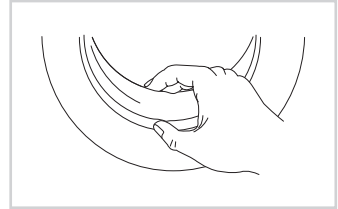

GB

Cleaning The Inlet Filter

Note!

- Inlet filter must be cleaned if there is less water.

Washing the filter in the tap

1. Close the tap.
2. Remove the water supply hose from the tap.
3. clean the filter.
4. Reconnect the water supply hose.

Washing the filter In washing machine:

1. Screw off the inlet pipe from the backside of the machine.
2. Pull out the filter with long nose pliers and reinstall it back after being washed.
3. Use the brush to clean the filter.
4. Reconnect the inlet pipe.

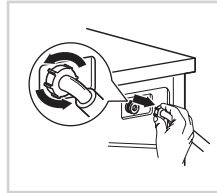
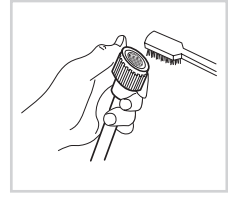
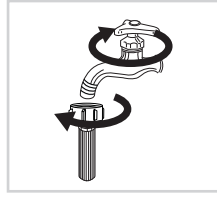

GB

Note!

- If the brush is not clean, you can pull out the filter washed separately;
- Reconnect, turn on the tap.

Clean The Detergent Dispenser

1. Press down the arrow location on softener cover inside the dispenser drawer.
2. Lift the clip up and take out softener cover and wash all grooves with water.
3. Restore the softener cover and push the drawer into position.

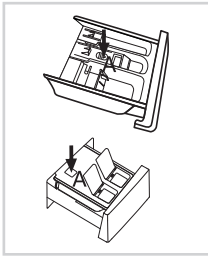

Pull out the dispenser drawer with press the A

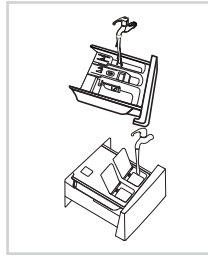

Clean the dispenser drawer under water

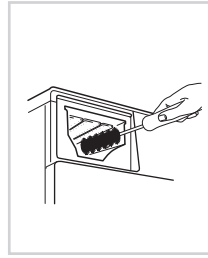

Clean inside the recess with an old toothbrush

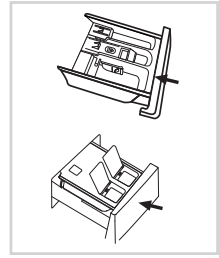

Insert the dispenser drawer

Note!

- Do not use alcohol, solvents or chemical products to clean the machine.

GB

Cleaning The Drain Pump Filter

Warning!

- Be careful of the hot water!
- Allow detergent solution to cool down.
- Unplug the machine to avoid electrical shock before washing.
- Drain pump filter can filter the yarns and small foreign matters from the washing.
- Clean the filter periodically to ensure the normal operation of washing machine.

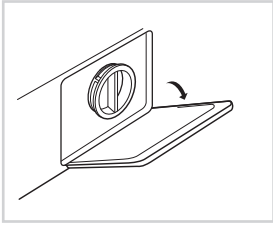

Open the lower cover cap

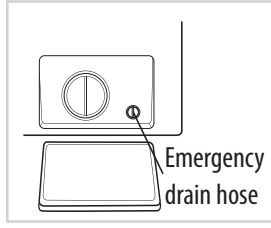

Rotate 90° and pull out the emergency drain hose, and take off the hose cap

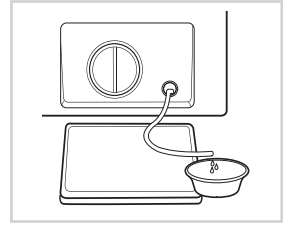

After water runs out, reset the drain hose

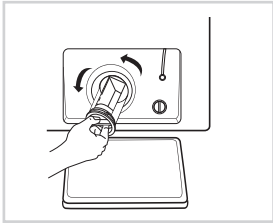

Open the filter by turning to the counterclockwise

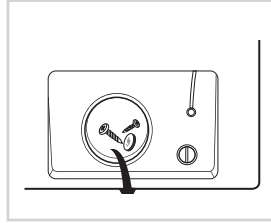

Remove extraneous matter

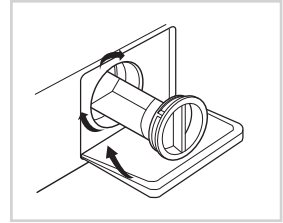

Close the lower cover cap

GB

⚠ Caution!

- Make sure that valve cap and emergency drain hose are reinstalled properly, cap plates should be inserted aligning to hole plates otherwise water may leak.
- Some machines don't have emergency drain hose, so step 2 and step 3 can be skipped. Rotate lower cover cap directly to make water run into basin.

- When the appliance is in use and depending on the programme selected there can be hot water in the pump. Never remove the pump cover during a wash cycle, always wait until the appliance has finished the cycle, and is empty. When replacing the cover, ensure it is securely re-tightened.

Trouble Shooting

The start of the appliance does not work or it stops during operation. First try to find a solution to the problem, If not, contact the service centre.

Description	Reason	Solution
Washing machine cannot start up	Door is not closed properly	Restart after the door is closed Check if the clothes is stuck
Door can't be opened	Washer's safety protection design is working	Disconnect the power, restart the product
Water leakage	The connection between inlet pipe or outlet hose is not tight	Check and fasten water pipes Clean up outlet hose
Detergent residues in the box	Detergent is dampened or agglomerated	Clean and wipe the detergent box

Indicator or display does not light	Disconnect the power PC board or harness has connection problem	Check if the power is shut down and the power plug is connected correctly
Abnormal noise		Check if the fixing (bolts) have been removed Check it's installed on a solid and level floor
E30	Door is not closed properly	Restart after the door is closed Check if the clothes is stuck
E10	Water injecting problem while washing	Check if the water pressure is too low Straighten the water pipe Check if the inlet valve filter is blocked

E21	Overtime water draining	Check if the drain hose is blocked
E12	Water overflow	Restart the washer
EXX	Others	Please try again first, call up service line if there are still troubles

Note!

- After the check, activate the appliance. If the problem occurs or the display shows other alarm codes again, contact the service.

Technical Specifications

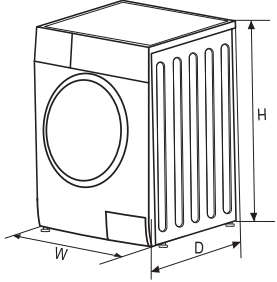
Power Supply	220-240V~,50Hz	
MAX. Current	10A	
MAX Water Pressure	1MPa	

Model	Washing Capacity	Dimension (W*D*Hmm)	Net Weight	Rated Power
SABA FL914L21W	9.0kg	595*565*850	71kg	2000W
SABA FL1015L21W	10.0kg	595*565*850	72kg	1950W
SABA FL1214L21W	12.0kg	595*595*850	73kg	2000W

GB

Product fiche

Product fiche concerning to Regulation (EU) No 2019-2014

Supplier's name or trademark: SABA				
Supplier's address (b): 80 boulevard du Mandinet, 77432 Marne la Vallée, Cedex 2				
Model identifier:FL914L21W				
General product parameters:				
Parameter	Value	Parameter	Value	
Rated capacity (") (kg)	9.0	Dimensions in cm	Height	85
			Width	60
			Depth	57
EElw (°)	59.9	Energy efficiency class (a)	B	
Washing efficiency index (°)	1.04	Rinsing effectiveness (g/kg) (a)	5.0	

Energy consumption in kWh per cycle, based on the eco 40-60 programme. Actual energy consumption will depend on how the appliance is used.	0.57		Water consumption in litre per cycle, based on the eco 40-60 programme. Actual water consumption will depend on how the appliance is used and on the hardness of the water.	49	
Maximum temperature inside the treated textile (°) (°C)	Rated capacity	34	Remaining moisture content (a) (%)	Rated capacity	53
	Half	34		Half	53
	Quarter	21		Quarter	53
Spin speed (°) (rpm)	Rated capacity	1400	Spin-drying efficiency class (a)	B	
	Half	1400			
	Quarter	1400			
Programme duration (°) (h:min)	Rated capacity	3: 48	Type	free-standing	
	Half	2: 54			
	Quarter	2: 54			
Airborne acoustical noise emissions in the spinning phase (°) (dB(A) re 1 pW)	76		Airborne acoustical noise emission class (a) (spinning phase)	B	
Off-mode (W)	0.50		Standby mode (W)	N/A	
Delay start (W) (if applicable)	4.00		Networked standby (W) (if applicable)	N/A	
Minimum duration of the guarantee offered by the supplier :24months					
This product has been designed to release silver ions during the washing cycle			NO		

Additional information:

Weblink to the supplier's website, where the information in point 9 of Annex II to Commission Regulation (EU) 2019/2023 (1) ^(b) is found: www.conforama.fr

(a) For the eco 40-60 programme.

(b) changes to these items shall not be considered relevant for the purposes of paragraph 4 of Article 4 of Regulation (EU) 2017/1369. If the product database automatically generates

(c) If the product database automatically generates the definitive content of this cell the supplier shall not enter these data.

Product fiche concerning to Regulation (EU) No 2019-2014

Supplier's name or trademark: SABA

Supplier's address ft:

Model identifier: FL1015L21W

General product parameters:

Parameter	Value	Parameter	Value	
Rated capacity (") (kg)	10.0	Dimensions in cm	Height	85
			Width	60
			Depth	57
EElw ^(a)	60.0	Energy efficiency class ^(a)	B	
Washing efficiency index ^(a)	1.04	Rinsing effectiveness (g/kg) ^(a)	5.0	
Energy consumption in kWh per cycle, based on the eco 40-60 programme. Actual energy consumption will depend on how the appliance is used.	0.593	Water consumption in litre per cycle, based on the eco 40-60 programme. Actual water consumption will depend on how the appliance is used and on the hardness of the water.	52	

Maximum temperature inside the treated textile ft (°C)	Rated capacity	38	Remaining moisture content ft (%)	Rated capacity	53
	Half	38		Half	53
	Quarter	23		Quarter	53
Spin speed (a) (rpm)	Rated capacity	1500	Spin-drying efficiency class (a)	B	
	Half	1500			
	Quarter	1500			
Programme duration (°) (h:min)	Rated capacity	3 : 59	Type	free-standing	
	Half	3 : 00			
	Quarter	3 : 00			
Airborne acoustical noise emissions in the spinning phase (a) (dB(A) re 1 pW)	80		Airborne acoustical noise emission class (a) (spinning phase)	C	
Off-mode (W)	0.50		Standby mode (W)	N/A	
Delay start (W) (if applicable)	4.00		Networked standby (W) (if applicable)	N/A	
Minimum duration of the guarantee offered by the supplier :24months					
This product has been designed to release silver ions during the washing cycle			NO		
Additional information:					
Weblink to the supplier's website, where the information in point 9 of Annex II to Commission Regulation (EU) 2019/2023 (1) (b) is found: www.conforama.fr					
(a) For the eco 40-60 programme. (b) changes to these items shall not be considered relevant for the purposes of paragraph 4 of Article 4 of Regulation (EU) 2017/1369. fi if the product database automatically generates (c) If the product database automatically generates the definitive content of this cell the supplier shall not enter these data.					

GB

Supplier's name or trademark: SABA					
Supplier's address ft:					
Model identifier: FL1214L21W					
General product parameters:					
Parameter	Value		Parameter	Value	
Rated capacity (") (kg)	12.0		Dimensions in cm	Height	85
				Width	60
				Depth	60
EEIw (a)	60.0		Energy efficiency class (a)	B	
Washing efficiency index (a)	1.04		Rinsing effectiveness (g/kg) (a)	5.0	
Energy consumption in kWh per cycle, based on the eco 40-60 programme. Actual energy consumption will depend on how the appliance is used.	0.628		Water consumption in litre per cycle, based on the eco 40-60 programme. Actual water consumption will depend on how the appliance is used and on the hardness of the water.	57	
Maximum temperature inside the treated textile ft (°C)	Rated capacity	40	Remaining moisture content ft (%)	Rated capacity	53
	Half	38		Half	53
	Quarter	20		Quarter	53
Spin speed (°) (rpm)	Rated capacity	1400	Spin-drying efficiency class (°)	B	
	Half	1400			
	Quarter	1400			

GB

Programme duration ([®]) (h:min)	Rated capacity	4 : 00	Type	free-standing
	Half	3 : 00		
	Quarter	3 : 00		
Airborne acoustical noise emissions in the spinning phase (^²) (dB(A) re 1 pW)	80		Airborne acoustical noise emission class (^³) (spinning phase)	C
Off-mode (W)	0.50		Standby mode (W)	N/A
Delay start (W) (if applicable)	4.00		Networked standby (W) (if applicable)	N/A
Minimum duration of the guarantee offered by the supplier:24months				
This product has been designed to release silver ions during the washing cycle			NO	
Additional information:				
Weblink to the supplier's website, where the information in point 9 of Annex II to Commission Regulation (EU) 2019/2023 (1) (b) is found: www.conforama.fr				
<p>(^¹) For the eco 40-60 programme.</p> <p>(^²) changes to these items shall not be considered relevant for the purposes of paragraph 4 of Article 4 of Regulation (EU) 2017/1369. If the product database automatically generates</p> <p>(^³) If the product database automatically generates the definitive content of this cell the supplier shall not enter these data.</p>				

Disposal of old electrical appliances



The European directive 2012/19/EU on Waste Electrical and Electronic Equipment (WEEE), requires that old household electrical appliances must not be disposed of in the normal unsorted municipal waste stream. Old appliances must be collected separately in order to optimize the recovery and recycling of the materials they contain, and reduce the impact on human health and the environment.

The crossed out “wheeled bin” symbol on the product reminds you of your obligation, that when you dispose of the appliance, it must be separately collected.

Consumers should contact their local authority or retailer for information concerning the correct disposal of their old appliance.



SABA is a trademark of Technicolor or its affiliates used under license by Conforama.



SABA is a German brand born in 1923 in the heart of the Black Forest.

A pioneer in electronic equipment, it continues offering innovative and high quality products that will accompany you on a daily basis.

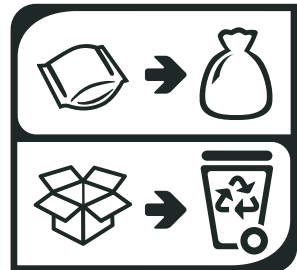

FRANCE ONLY