

2002

2036

2024

2023

2027

2034

2019

2033

2950

2952

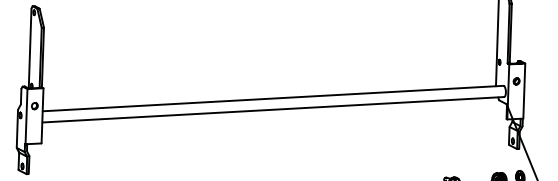
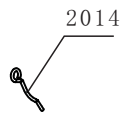
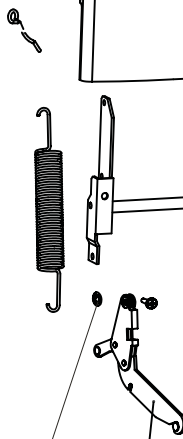
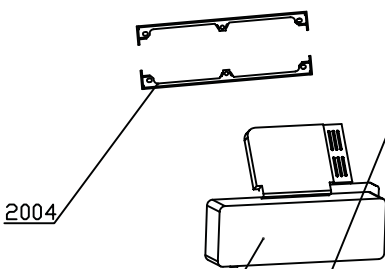
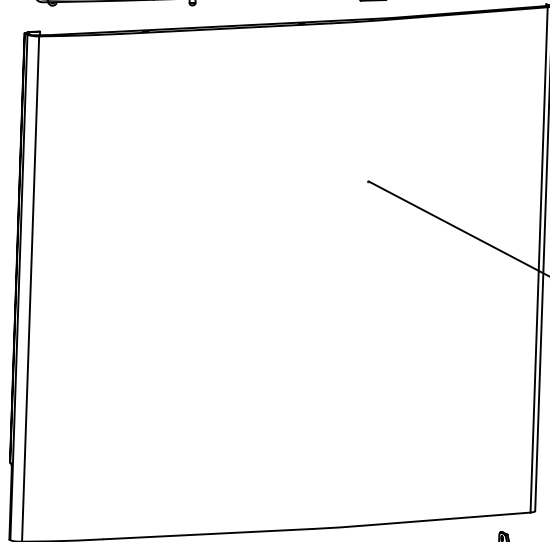
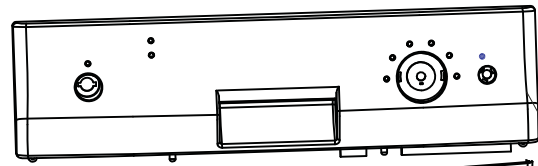
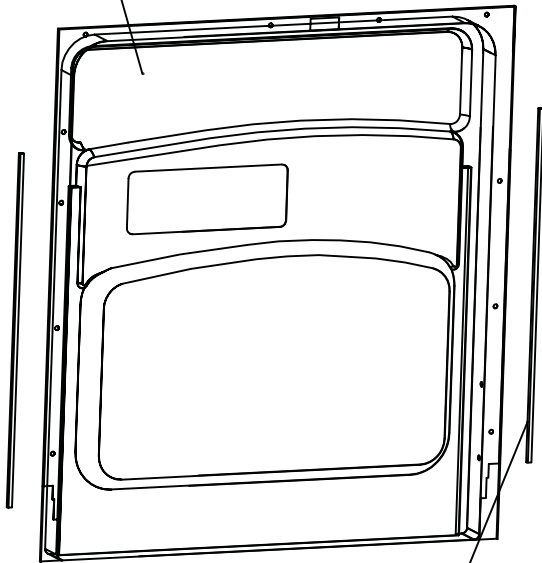

2005

2001

2006

2008

2009

2010

2011

2012

2013

2/3

2004

2018

2017

2014

2018

2013

2012

2/3

