

FAR

DP300WDIL

FR

GB



CONFORAMA France SA
80 Boulevard du Mandinet
LOGNES
77432 Marne la Vallée Cedex 2
FRANCE

CKFAR-C01

Enlèvement des appareils ménagers usagés



La directive européenne 2012/19/EU sur les Déchets des Equipements Electriques et Electroniques (DEEE), exige que les appareils ménagers usages ne soient pas jetés dans le flux normal des déchets municipaux. Les appareils usagés doivent être collectés séparément afin d'optimiser le taux de récupération et le recyclage des matériaux qui les composent, et réduire l'impact sur la santé humaine et l'environnement. Le symbole de la poubelle barrée est apposé sur tous les produits pour rappeler les obligations de collecte séparée. Les consommateurs devront contacter les autorités locales ou leur revendeur concernant la démarche à suivre pour l'enlèvement de leur vieil appareil.



FR

Thank you for choosing FAR quality. This product has been developed by our team of professional and according to European regulations. In order to get the most out of your new appliance, we recommend that you read this instruction manual carefully and keep it for future reference.

TABLE OF CONTENTS

Safety instructions	38
Technical information.	43
Description of the device	44
Installation	45
Use	46
Use the water dispenser	52
Reverse door	54
Maintenance	60
Cleaning	63
Troubleshooting	67
Accessories	68
Disposal.	68
Removal devices household uses	69

GB

Safety instructions

- IMPORTANT SAFETY INSTRUCTIONS: READ CAREFULLY AND KEEP FOR FUTURE REFERENCE
- This appliance is intended to be used in household and similar applications such as:
 - staff kitchen areas in shops, offices and other working environments;
 - farm houses;
 - by clients in hotels, motels and other residential type environments;
 - bed and breakfast type environments;
- This product is not intended for use in the following applications
 - catering and other similar applications and retail
- WARNING: Keep ventilation openings, in the appliance enclosure or in the built-in structure, clear of obstruction.
- WARNING: Do not use mechanical devices or other means to accelerate the defrosting process, other than those recommended by the manufacturer.
- WARNING: Do not damage the refrigerant circuit.
- If the refrigerant circuit is damaged:

- Avoid naked flames and sources of ignition.
- Thoroughly ventilate the room in which the appliance is situated.
- WARNING: Do not use electrical appliances inside the food storage compartments of the appliance, unless they are of the type recommended by the manufacturer.
- Children aged from 3 to 8 years are allowed to load and unload **refrigerating appliances**.
- This appliance can be used by children aged from 8 years and above and persons with reduced physical, sensory or mental capabilities or lack of experience and knowledge if they have been given supervision or instruction concerning use of the appliance in a safe way and understand the hazards involved. Children shall not play with the appliance. Cleaning and user maintenance shall not be made by children without supervision.
- WARNING: When positioning the appliance, ensure the supply

cord is not trapped or damaged.

- If the supply cord is damaged, it must be replaced by the manufacturer, its service agent or similarly qualified persons in order to avoid a hazard.
- WARNING: Do not locate multiple portable socket-outlets or portable power supplies at the rear of the appliance.
- GB • WARNING: To avoid a hazard due to instability of the appliance, it must be fixed in accordance with the instructions.
- Do not store explosive substances such as aerosol cans with a flammable propellant in this appliance.
- WARNING: fill the ice-maker with potable water only.
- For information on the installation, handling, maintenance and disposal of the device, and the method of replacing the lamp, please refer to the following paragraphs of this manual.
- For the replacement method of light bulb, refer to <Changing the light bulb>.
- Gas warning



WARNING: risk of fire/flammable materials

- To avoid contamination of food, please respect the following instructions:
 - Opening the door for long periods can cause a significant increase of the temperature in the compartments of the appliance.
 - Clean regularly surfaces that can come in contact with food and accessible drainage systems.
 - Clean water tanks if they have not been used for 48 h; flush the water system connected to a water supply if water has not been drawn for 5 days.
 - Store raw meat and fish in suitable containers in the refrigerator, so that it is not in contact with or drip onto other food.
 - Two-star frozen-food compartments are suitable for storing pre-frozen food, storing or making ice-cream and making ice cubes.
 - One-, two- and three-star compartments are not suitable for the freezing of fresh food.
 - If the **refrigerating appliance** is left empty for long periods, switch off, defrost, clean, dry, and leave the door open to prevent mould developing within the appliance.

WARNINGS

- If you are discarding an old freezer or refrigerator with a lock / catch fitted to the door, ensure that it is left in a disabled condition to prevent the entrapment of young children when playing.
- As old refrigeration equipment may contain CFC's which will damage the ozone layer, when disposing of any refrigeration equipment please contact your local waste disposal department for advice on the correct method of disposal.
- Unplug the appliance from the mains socket when not in operation and before cleaning. Remove food before cleaning the appliance.
- Do not insert oversized food as this could cause incorrect operation.
- Extreme caution must be used when moving an appliance.
- To turn the appliance off, turn the thermostat knob fully anticlockwise to OFF, then remove the plug from the mains socket.
- Do not give children ice-cream and water ices direct from the freezer as the low temperature may cause 'freezer burns' on the lips.

- The appliance must be installed on the ground, on a flat, horizontal surface, making sure that the ventilation openings are completely clear.
Never try to replace or repair any part or component of the appliance yourself; seek the assistance of professional, qualified personnel, if need be.

Technical information

Brand	FAR
Model	DP300WDIL
Category of household refrigerating appliance	Catalogue 7
Energy class	A+
Annual energy consumption	266 kWh/an
Storage volume	Refrigerator : 232L Freezer : 76L 
Defrost	Refrigerator: automatic Freezer : manuel
Autonomy	22 h
Freezing capacity	4 kg / 24h
Climate class + Ambient range	ST (+16°C to +38°C)
Noise	42 dB(A) re 1pW
Rated voltage and frequency / Input power	220V-240V / 50Hz~ 105W
Lamp	230V / 50Hz - 10W max E14 type

Refrigerant / Amount	R600a / 50g
Product dimension (L x W x H)	605 x 600 x 1720 (mm)
Net weight	50 kg
Type of installation	Free Standing

(1) Calculation on the basis of results for 24 hours under standard test conditions. The actual energy consumption will depend on use and the location of the device.

GB

Description of the device

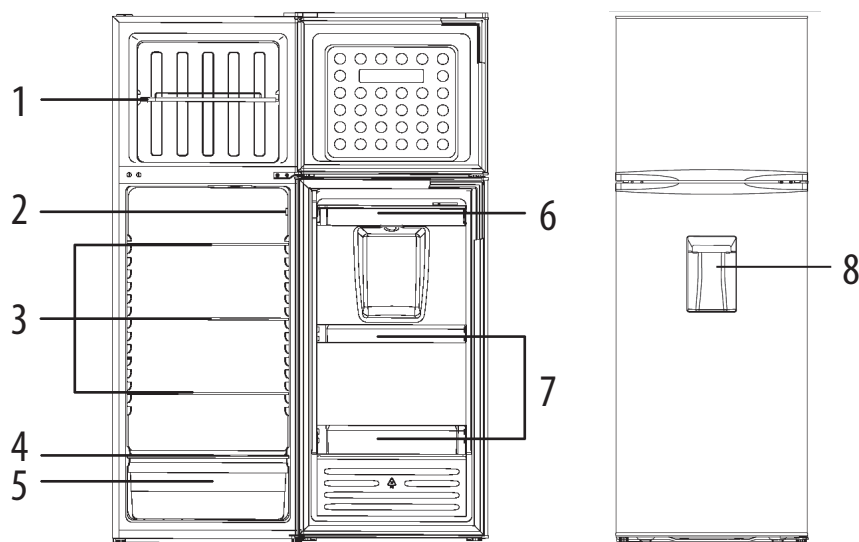

1. Freezer shelf
2. Thermostat and Light
3. Glass shelves
4. Crisper Cover
5. Crisper
6. Water tank for water dispenser
7. Balconies
8. Water dispenser

NOTE: The appliance design is subject to change without prior notice.

Installation

GB

Position the appliance and allow it to stand for two to three hours before it is turned on for the first time to allow the system to settle. Do not position next to any heat source e.g. cooker, boiler or in direct sunlight etc.

Allow at least 10 cm of space at the top and 10 cm of space on both sides of the appliance and between the back of the appliance and the wall for adequate air circulation. The appliance is not designed for recessed installation ("building in").

Install on a good firm level surface, and any unevenness of the floor should be corrected prior to installation, slight unevenness can be overcome by adjusting the front feet.

NOTE: If the appliance is positioned on a carpet, soft floor covering you should readjust the front feet once the appliance has had time to settle.

Use

Position different food in different compartments according to be below table.

Refrigerator compartments	Type of food
Door or balconies of fridge compartment	<ul style="list-style-type: none"> . Foods with natural preservatives, such as jams, juices, drinks, condiments. . Do not store perishable foods.
Crisper drawer (salad drawer)	<ul style="list-style-type: none"> . Fruits, herbs and vegetables should be placed separately in the crisper bin. . Do not store bananas, onions, potatoes, garlic in the refrigerator.
Fridge shelf – bottom Chiller (box/drawer)	Raw meat, poultry, fish (for short-term storage)
Fridge shelf – middle	Dairy products, eggs
Fridge shelf –top	Foods that do not need cooking, such as ready-to-eat foods, deli meats, leftovers.

Freezer drawer (s)/shelf

- . Foods for long-term storage.
- . Bottom drawer/shelf for raw meat, poultry, fish.
- . Middle drawer/shelf for frozen vegetables, chips.
- . Top drawer/shelf for ice cream, frozen fruit, frozen baked goods.

- This appliance is designed to operate in ambient temperature between 16°C and 38°C. If these temperatures are exceeded, i.e. colder or warmer, the appliance will not operate correctly. If the ambient temperatures are exceeded for long periods, the temperature in the freezer section will rise above -18°C and food spoilage may occur.
- Remove all packaging materials from the appliance. Wash the inside of the cabinet with lukewarm water and bicarbonate of soda (5ml to 0.5 liter of water). Dry the appliance thoroughly.

- When you use the freezer for the first time or after defrosting, set the thermostat control to the maximum position for at least 2 hours before introducing food to be stored, and then readjust to the normal position.
- If there is a power failure, do not open the door. Frozen food should not be affected if the failure lasts for less than 12 hours. If the failure is longer, then the food should be checked and either eaten immediately or cooked and then re-frozen.

Setting the thermostat knob

The refrigerator is controlled with a thermostat knob located inside the fridge, towards the upper right-hand corner. Turn the knob from the STOP (0) position towards the higher numbers for colder temperatures. The knob can be adjusted from setting 1 to 7. Higher settings on the knob (higher numbers) mean lower temperatures (colder) in all compartments of the appliance. Changes of the ambient temperature affect temperature in the interior of the appliance so choose a correct setting of the temperature control knob, depending on your ambient conditions. In the STOP (0) position the appliance does not operate (the cooling system is switched off), but power supply is not interrupted. Set the thermostat knob to a middle position to achieve -18°C in the freezer compartment.

Please Note:

If the appliance is switched off you must wait at least 5 minutes before restarting the appliance or re-inserting the plug into the wall outlet. This is to allow the protection device in the compressor to reset.

If the compressor fails to start correctly remove the plug and wait for 5 minutes before you try again then the compressor should restart normally.

The storage temperature may be affected by:

- The room temperature
- How often the door is opened
- How much food is stored
- Position of the appliance

When you set the correct temperature, all these factors mentioned above shall be taken into account.

Temperature indicate

In order to help you get the correct adjustment of your device, it is equipped with a temperature gauge placed in the coldest area. For the proper storage of food in your refrigerator and in particular in the coldest area, make sure that "OK" appears in the temperature indicator.



The symbol on the left side indicates the location of the coldest area of your refrigerator. It defines the height of this area.

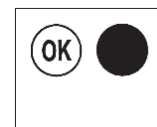

If "OK" is not displayed, the average temperature in this area will be very high. You ought to adjust the thermostat to a colder setting.

For every modification of your thermostat, you are supposed to wait for the stabilization of the temperature inside the unit before proceeding, if necessary, to a new setting. Do change the position of the thermostat gradually and wait at least 12 hours before re-checking.

NOTE: after charging the device for fresh food or after repeated or prolonged door openings, it is normal that the inscription "OK" does not appear in the temperature indicator. Wait at least 12 hours before readjusting the thermostat.

GB

Shopping for frozen food

The appliance is rated as a 4 star freezer and can freeze fresh food and store pre-frozen food. When you are buying frozen food, look at the Storage Guidelines on the packaging. You will be able to store each item of frozen food for the period shown against the 4 star rating.

Freezing fresh food

Ensure that your freezing operations are carried out under the most hygienic conditions as freezing alone does not improve the food. Never put hot or even warm foodstuffs into the freezer.

Prior to freezing the food, food should always be covered tightly with foil, plastic film, placed in plastic bags or stored in airtight containers. This will prevent food from dehydrating and to prevent any strong odors of some foods transferring to milder ones. To freeze raw meat, wrap in plastic bags or in airtight containers and place on the lowest shelf to avoid cross contamination.

Do not allow raw meat to come into contact with cooked foods. Fruit and vegetables should be thoroughly cleaned and placed in the crisper.

Milk and other liquids should be sealed with lids and placed in the bottle shelf in the door.

NOTE: The ambient temperature of the freshly stored food and how often the door is opened affect the temperature in the refrigerator. If required, change the thermostat temperature settings.

Storing frozen food

All frozen food you purchase should be placed in the freezer as soon as possible to avoid them from defrosting and spoiling. All storage recommendations printed on the packaging of frozen food by the manufacturer should always be followed.

When using the freezer for the first time or after defrosting, set the thermostat knob to the maximum position for at least 2 hours before introducing food to be stored, and then readjust it to the normal position.

Energy-saving tips

Install the fridge or freezer in a cool place out of direct sunlight and away from cookers, heaters, dishwashers or any hot air emitting items.

Do not set the fridge and freezer temperatures lower than necessary. Set the internal temperature within the correct range e.g. adjust the thermostat at middle position for 4°C in the fridge compartment and -18°C in the freezer respectively.

GB

Let pre-cooked foods cool down before placing them in the fridge or freezer. This will prevent the internal temperature of the fridge from rising.

Keep your fridge full, but not over crowded, this helps reduce “cold” air loss. Meanwhile, avoid overloading the fridge or freezer. Try to leave about 20% free space for air circulation.

To prevent cold air escaping, limit the frequency of opening door. When returning from shopping, sort foods to be kept in your fridge before opening the door. Only open the door to put food in or take it out.

Make sure the door seal is clean and in good condition. It should hold a piece of paper tightly in place when shut.

Defrost regularly or when ice is more than 5 mm thick. Thick ice covering the inner sides significantly increases energy use.

The combination of the drawers, baskets and shelves shown in the device description is optimal for efficient energy savings.

Changing the combination proposition could alter the efficiency.

Use the water dispenser

With the water dispenser, you can obtain cold water easily without opening the refrigerator door.

Detach and clean water tank.

1. Hold both sides of tank to lift out it.
2. Pull tank cover to detach it from tank.

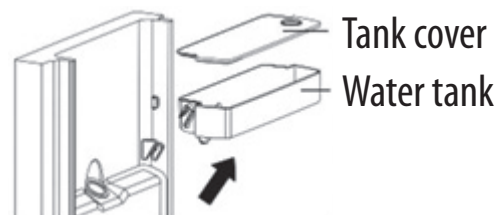

3. Wholly clean tank balcony, cover and tank.
4. Replace water tank, cover and tank balcony.

Fill the water tank with water

1. Ensure the water tank is stable before fill it.
2. Open the lid on tank.
3. Fill with water up to max level. If it's filled higher than this, it may overflow when the lid is closed.

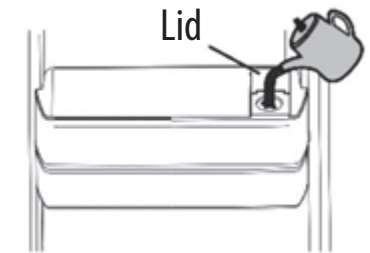

⚠ CAUTION! Fix water tank to the fridge door tightly. If not, water tank may not be operated correctly.

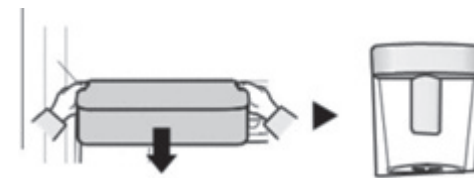

Using the dispenser

Place a cup underneath the water outlet and push gently against the dispenser lever with your cup. Make sure the cup is in line with the dispenser to prevent the water from bouncing out.

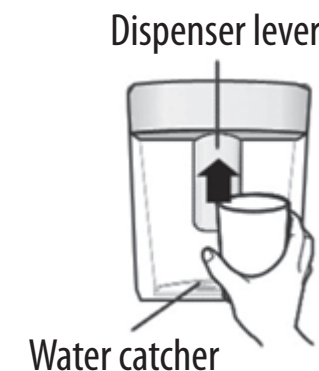

⚠ CAUTION! It's normal that some drips are out of cup after you loose the dispenser level. The water will be collected in the water catcher. Empty the water catcher when it is full. If not, the water catcher will overflow.

Reverse door

This refrigerator can be opened either from the left or right side. The default way of opening the door is from the right left. If you want to open the door from the left side, please follow the instructions below.

Tools Required: Phillips style screwdriver / Flat blated screwdriver / Hexagonal spanner

- If you want to have the door swing reversed, we recommend that you contact a qualified technician. You should only try to reverse the door yourself if you believe that you are qualified to do so.
- Ensure the unit is unplugged and empty.
- Adjust the two levelling feet to their highest position.
- To take the door off it is necessary to tilt the unit backwards. You should rest the unit on something solid so that it will not slip during the door reversing process.
- All parts removed must be saved to do the reinstallation of the door.
- The refrigerator inclination angle should be less than 45°.

- Do not lay the unit fat as this may damage the coolant system.
 - You should rest the Appliance on something solid e.g. a chair just below the top panel.
 - We recommend that 2 people handle the unit during assembly.
- Follow the following stages to reverse the door from its initial position.

DEPOSIT DOORS

1. Unscrew top hinge cover and then screw the top hinge. Then lift upper door and place it on a soft pad to avoid scratch and damage.

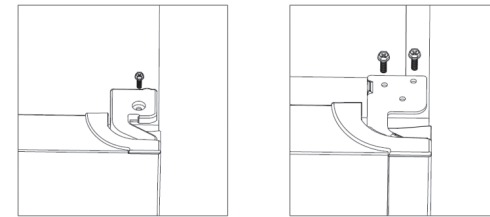

2. Remove the pin with a screw driver and flip the hinge bracket. Then refit the pin to hinge bracket.

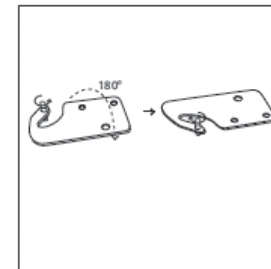

3. Remove the top left screw cover.

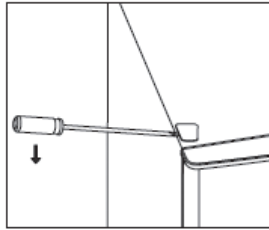

4. Unscrew the middle hinge.

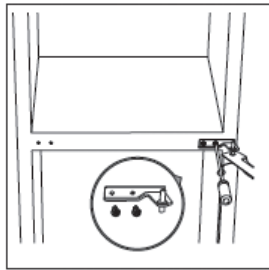

5. Move hinge hole cover in lower door to another side. Then lift lower door and place it on a soft pad to avoid scratch.

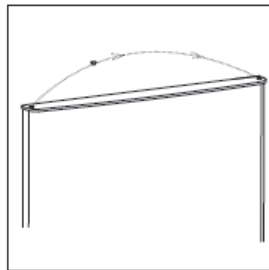

6. Move the hinge hole covers from the left side to right side.

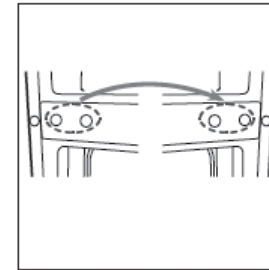

7. Unscrew bottom hinge. Then remove adjustable feet from both sides.

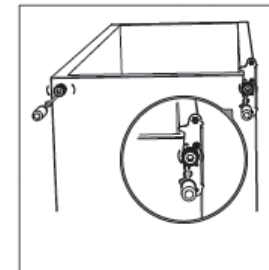

8. Unscrew and remove the bottom hinge pin, replace it by the provided spare bracket and fix it firmly.

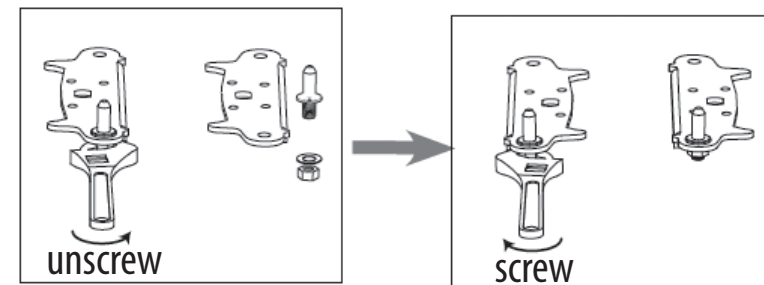

9. Refit the bracket fitting the bottom hinge pin. Replace both adjustable feet. Transfer the lower door to the property position.

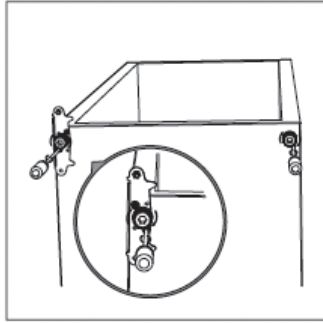

10. Make the middle hinge reverse direction 180°, then transfer it to the left property position. Make the middle hinge pin in the upper hole of the lower door, then tight the bolts.

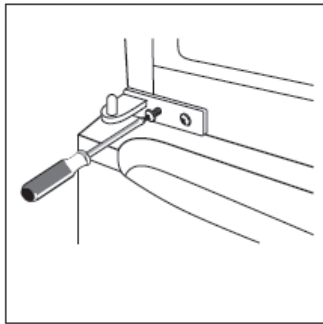

11. Place the upper door back on. Ensure the door is aligned horizontally and vertically so that the seal are closed on all side before finally tightening the top hinge. Then insert the top hinge and screw it to the top of until and then fix hinge cover (in accessory bag) by screw.

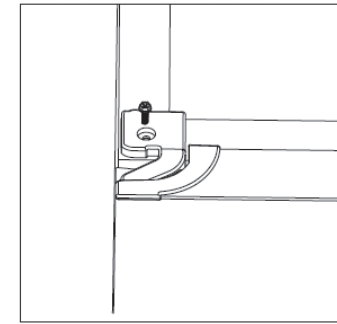
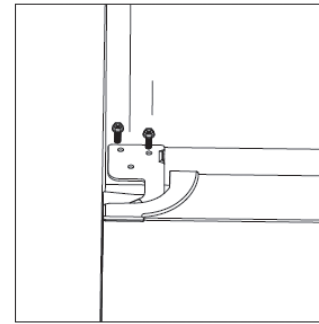

12. Fix the screw cover.

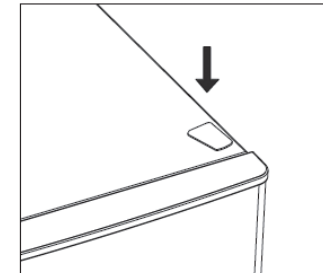

Maintenance

FRIDGE DEFROSTING

The fridge defrosting process is carried out automatically every time the compressor stops.

The defrost water is automatically routed to the drain port and into a tray placed on the top of the compressor to the rear of the appliance from which it evaporates.

Make sure the drain port on the fridge at the rear of the appliance is kept clear.

GB

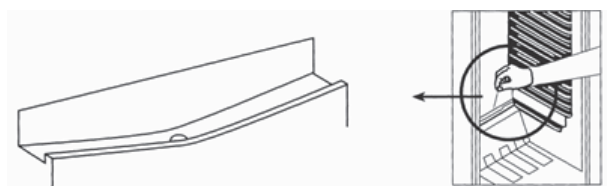

FREEZER DEFROSTING

Frost will accumulate inside the freezer depending upon the length of time during which the door is left open or the amount of moisture introduced.

It is essential to ensure that no frost or ice is allowed to form at places where it will affect the close fitting of the door seal.

This might allow air to penetrate the cabinet, thus encouraging continuous running of the compressor.

Thin frost formation is quite soft and can be removed with a brush or plastic scraper. Do not use metal or sharp scrapers, mechanical devices or other means to accelerate the defrosting process. Remove all dislodged frost from the cabinet floor.

60

For the removal of thin frost it is not necessary to switch off the appliance.

For the removal of heavy ice deposits disconnect the appliance from the mains supply and empty the contents into cardboard boxes and wrap in thick blankets or layers of paper to keep them cold. Defrosting will be most effective if carried out when the freezer is empty, and it should be carried out as quickly as possible. An increase in temperature of frozen food packages during defrosting will shorten the storage life. Provided that the contents are well wrapped and placed in a cool area, they should keep for several hours.

Examine the contents when replacing them in the freezer and if some of the packages have thawed out.

After defrosting is finished clean the inside with a solution of warm water with a little bicarbonate of soda and then dry thoroughly.

Wash all removable parts in the same way and reassemble.

Reconnect the appliance to the mains supply and leave for 2 to 3 hours on setting number 7 before introducing the food back into the freezer and setting the thermostat to your normal setting.

NOISE FROM YOUR APPLIANCE

You may notice some rather unusual noises. The noises are caused by circulation of refrigerant in the cooling system. It has become more pronounced since the introduction of CFC free gases. This is not a fault and will not affect the performance of your fridge.

GB

61

PROLONGED OFF PERIODS

If the appliance is not in use for a long period of time, proceed as follows:

1. Disconnect from the mains supply.
2. Clean and dry the inside (see "Cleaning and maintenance").
3. Leave the door open to prevent any unpleasant smells from building up while the appliance is not in use.

NOTES FOR USE

Do clean and defrost your appliance regularly.

Do check contents of the compartments every so often.

Do store commercially prepared food in accordance with the instructions given on the packets.

Do choose high quality fresh food and be sure it is thoroughly clean before freezing it.

Do wrap all food in food quality polythene bags or air tight containers and make sure any air is excluded.

Do Not store poisonous or any dangerous substances in your freezer. It is designed for the freezing of edible foodstuffs only.

Do Not consume food which has been frozen for an excessive length of time.

Do Not leave the door open for long periods, as this will make the appliance more costly to run and cause excessive ice formation.

Do Not use sharp objects such as knives to remove the ice from the appliance. Only use a plastic scraper.

Do Not put hot food into the appliance. Let it cool down to room temperature.

Do Not put liquid-filled bottles or sealed cans containing carbonated liquids into the freezer as they may burst.

Do Not give children ice-cream and water ices direct from the freezer as the low temperature may cause 'freezer burns' on the lips. Do Not try to keep frozen food which has thawed; it should be eaten within 24 hours or cooked and re-frozen.

CHANGING THE LIGHT BULB

1. Set the thermostat knob to the off position (0) then unplug the appliance.
2. Remove the food.
3. Push upward to remove the light shield.
4. Unscrew the bulb and screw a new bulb of the same shape same power (230V-10W E14 base).
5. Attach the light shield.

Cleaning

Unplug the appliance.

Remove all substances.

Clean the inside and outside walls with a clean sponge or soft cloth using warm water or 1 teaspoon of bicarbonate of soda to 1.2 liters of water.

Rinse well and wipe dry with a clean soft cloth.

If the appliance is not to be used for a long period of time then it is recommended to remove all the food stuff, clean the inside of the appliance and leave the door open to allow the air

to circulate thus avoiding unpleasant odors.

Dusts behind the refrigerator and on the ground shall be timely cleaned to improve the cooling effect and energy saving.

The interior of the refrigerator should be cleaned regularly to avoid odor.

Check the door gasket regularly to make sure there are no debris.

GB

Please turn off the power before cleaning, remove all food, shelves, drawers, etc.

Clean the door gasket with mild soap and water. Use a soft cloth or sponge to clean the inside of the refrigerator, with two tablespoons of baking soda and a quart of warm water. Then rinse with water and wipe clean, and open the door and dry it naturally before the power is turned on.

For areas that are difficult to clean in the refrigerator (such as narrow sandwiches, gaps or corners), it is recommended to wipe them regularly with a soft rag, soft brush, etc. and when necessary, combined with some auxiliary tools (such as thin sticks) to ensure no contaminant accumulation in these areas. Do not use soap, detergent, scrub powder, spray cleaner, etc., as these may cause odors in the interior of the refrigerator.

Clean the bottle frame, shelves and drawers with a mild detergent and dry with a soft cloth.

Wipe the outer surface of the refrigerator with a soft cloth dampened with soapy water, detergent, etc., and then wipe dry.

Do not use hard brushes, clean steel balls, wire brushes, abrasives, such as toothpastes, organic solvents (such as alcohol, acetone, banana oil, etc.), boiling water, acid or alkaline items clean refrigerator considering that this may damage the fridge surface and interior. Boiling water and benzene may deform or damage plastic parts.

GB

Do not rinse with water so as not to affect the electrical insulation properties.

It is advisable to clean the appliance regularly and to remove any food deposits or splashes; in particular, clean the door seals, recesses and adjacent parts.

Don't overlook parts of the appliance such as the humidity controller, light casing, racks, egg and butter compartments, ice cube tray, and all of the drainage areas, etc.

If the appliance is not kept clean and in good condition, its surface could deteriorate and inexorably affect the length of its service life, and could lead to a dangerous situation.

The appliance must not be steam cleaned.

Use only a non-abrasive sponge, rinse with clean water then dry thoroughly before putting the parts back in place.

Never use abrasive cleaning products or hard metal scrapers to clean the appliance, as they could scratch the surfaces and break down the coating.

After cleaning, leave the inside of the appliance to dry with the door open before plugging it into the mains again.

When re-stocking the appliance, be especially careful not to hit, scratch, crack or break the internal surfaces.

GB

Troubleshooting

Before calling for service please check the following.

THE APPLIANCE IS NOT WORKING.

Check the plug is inserted correctly into the mains socket. Check there is power to the mains socket by plugging another appliance in, if the other appliance do not work either, check the fuse of the socket.

THE APPLIANCE IS NOISY WHEN OPERATING.

Check the appliance is level and it is not in contact with another appliance or kitchen furniture.

THE APPLIANCE DOES NOT COOL SUFFICIENTLY.

If the door has been opened too often or it has been left open for a while it will take time for the appliance to reach its set temperature. Check the airflow over the rear of the appliance has not been reduced due to insufficient clearance. Check if a large quantity of fresh food has been introduced.

THE WATER FLOW FROM THE WATER DISPENSER IS NOT FLUENT ENOUGH

If the water flow from the water dispenser is too small or not fluent enough, please follow below step to add a gasket for the water tank.

GB

1. Uninstall the water tank



2. Take the rubber gasket from the material bag and install it on the outlet of the dispenser nozzle.



3. Reinstall the water tank



GB

GB

Accessories

Energy label

FR/ENG manual

Rubber gasket for water tank

Kit for reversing the door

Disposal

The refrigerating gas contained in the circuit of this appliance is isobutane (R600a); it causes a low level of pollution but is inflammable. Please contact your local disposal department for advice on the correct method of disposal.

Removal devices household uses



The European directive 2012/19/EU on Waste Electrical and Electronic Equipment (WEEE), requires that old household electrical appliances must not be disposed of in the normal unsorted municipal waste stream. Old appliances must be collected separately in order to optimize the recovery and recycling of the materials they contain, and reduce the impact on human health and the environment.

The crossed out "wheeled bin" symbol on the product reminds you of your obligation, that when you dispose of the appliance, it must be separately collected.

Consumers should contact their local authority or retailer for information concerning the correct disposal of their old appliance.

